



NSCaster X2

User Manual

REV 2.2

www.Nagasoftsales.com

Copyright © 2006-2022 NANJING NAGASOFT CORPORATION
All rights reserved

Table of Contents

1 HARDWARE SPECIFICATION	1
1.1 LIST ACCESSORIES	1
1.2 DEVICE PARAMETERS	1
1.3 MODEL	2
1.4 INTERFACE DIAGRAM	2
1.4.1 Back Interface	2
1.4.2 Side Interface	3
2 SOFTWARE FEATURES	3
2.1 NSCASTER-X2 MAIN INTERFACE	3
2.1.1 PVW and PGM	4
2.1.2 HDMI Channel	4
2.1.3 NET Channel	5
2.1.4 DDR Channel	8
2.1.5 Image Overlay	9
2.1.6 PIP (Picture in Picture)	11
2.1.7 Scoreboard	12
2.1.8 Audio Mixer	13
2.1.9 Subtitle	13
2.1.10 CG	15
2.1.11 PTZ control	17
2.1.12 Special Effects	18
2.1.13 Chroma key	18
2.2 NSCASTER-X2 SETTINGS INTERFACE	19
2.2.1 Project	19
2.2.2 Recording	21
2.2.3 Streaming	21
2.2.4 Output	23
2.2.5 Network	24
2.2.6 Audio Settings	26
2.2.7 OSD Settings	27
2.2.8 File Transfer	28
2.2.9 General Settings	30
2.2.10 About	32

1 Hardware Specification

1.1 List Accessories

Name/Model	Package	Specification	Number of Pieces	Actual Quantity	Remarks
Main device	Aluminum box packaging	NSCasterX2	1	1	
Power supply and power cord	Aluminum box packaging	Standard	1	1	
5G antenna	Aluminum box packaging	Standard	4	4	Standard Version
Warranty card certificate	Aluminum box packaging	Nagasoft Custom	1	1	

1.2 Device Parameters

Device Item Name	Description
Chassis	Portable case, built-in with 13.3-inch high-definition touch screen
Dimensions	323mm*203mm*62mm (W x H x D)
Weight	1.75KG
Powered by	DC 19V
Transport box	Aluminium box packaging
Operating temperature	-10-50°C
Storage temperature	-20-70°C
Operating humidity	10~90% no condensation
Impact resistance	15g
Vibration resistance	10-100Hz 1.25g
Altitude	Below 4000 meters

1.3 Model



Front side



Back side

1.4 Interface Diagram

1.4.1 Back Interface

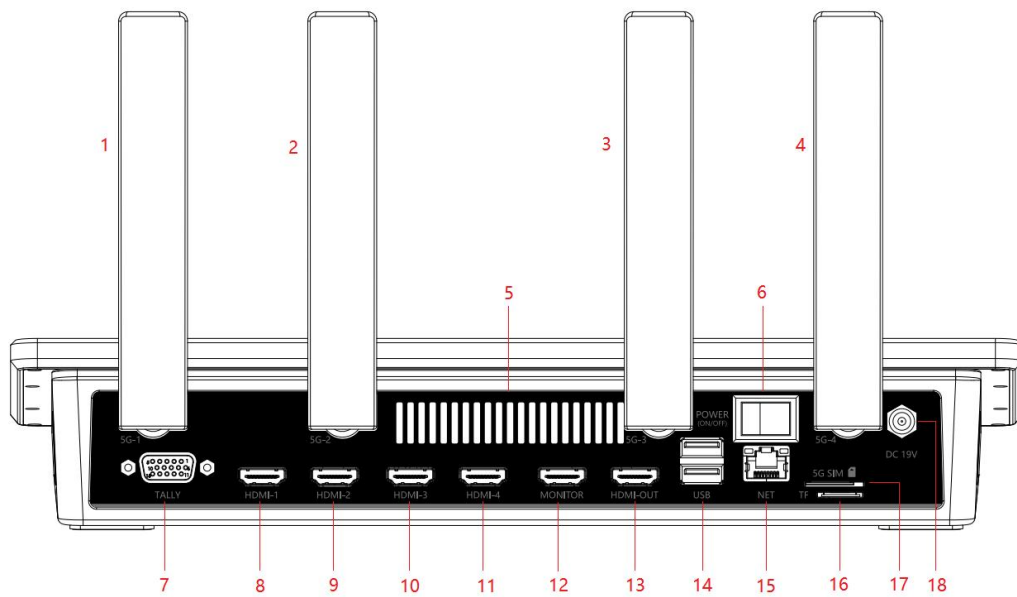

1	5G antenna	7	TALLY	13	HDMI PGM Output
2	5G antenna	8	HDMI-1 Input	14	USB2.0/3.0
3	5G antenna	9	HDMI-2 Input	15	Gigabit Ethernet port
4	5G antenna	10	HDMI-3 Input	16	TF card port
5	Cooling outlet	11	HDMI-4 Input	17	5G SIM port
6	Switch	12	HDMI Display interface	18	Power supply (DC 19V)

1.4.2 Side Interface

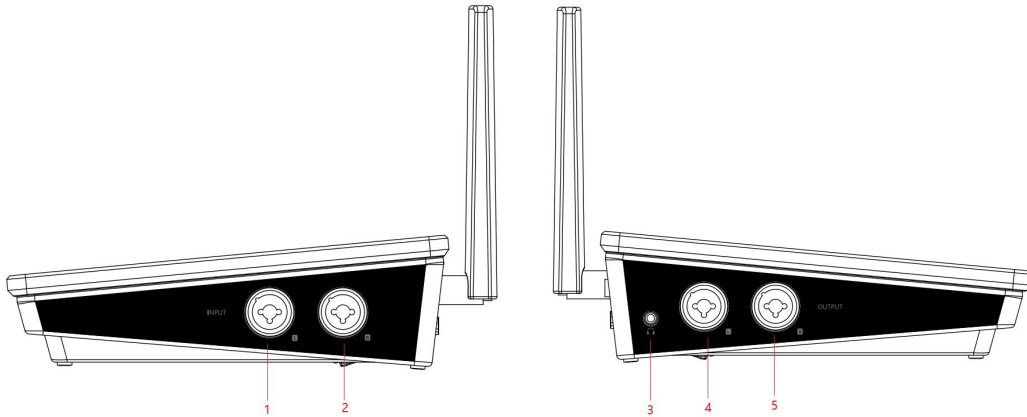

1	XLR/TRS balanced input L	4	XLR/TRS balanced output L
2	XLR/TRS balanced input R	5	XLR/TRS balanced output R
3	3.5mm monitor		

2 Software Features

2.1 NSCaster-X2 Main Interface

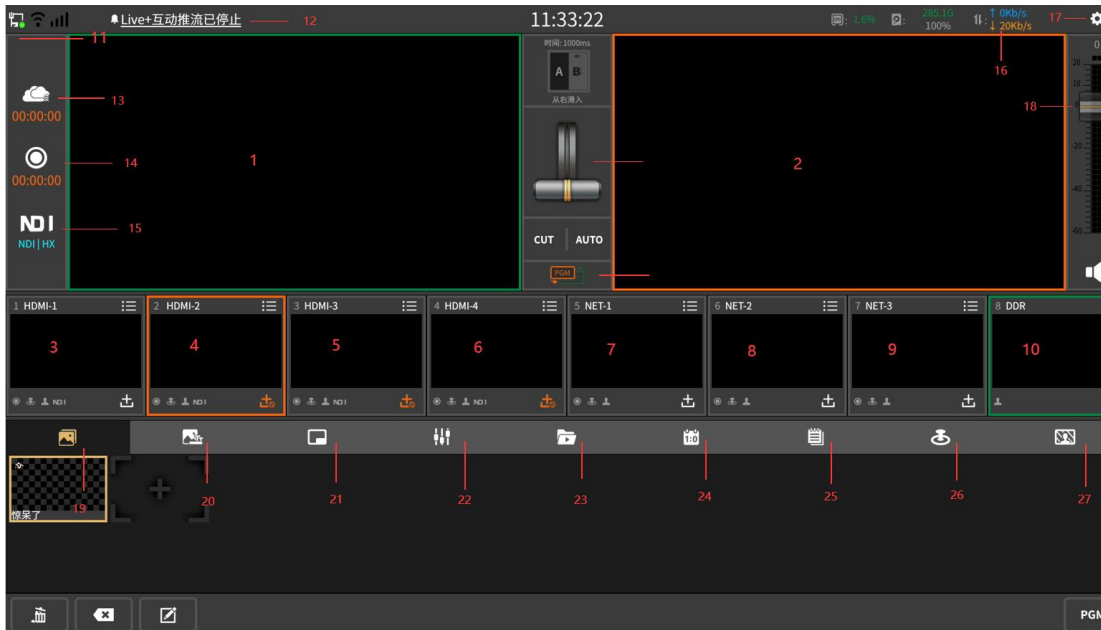

NO	Name	NO	Name
1	PVW	17	Settings button
2	PGM	18	Tuning control for total mix output
3-6	HDMI input channel	19	Image overlay
7-9	NET input channel	20	CG
10	DDR display channel	21	PIP (Picture in picture)
11	Network status display	22	Audio mixer
12	Log info	23	DDR local video play
13	Streaming control	24	Scoreboard
14	Recording control	25	Subtitle
15	NDI output control	26	PTZ control
16	Resource usage monitoring status	27	Chroma key

2.1.1 PVW and PGM

NSCaster X2 support video and audio signal in channel PGM and PVW

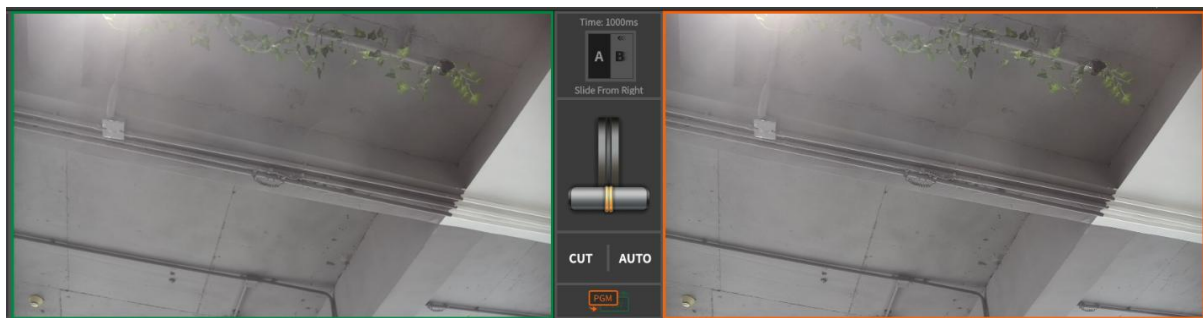

PGM channel: Orange channel is PGM channel, it monitors the screen that being broadcast.

PVW channel: Green channel is PVW channel, it monitors the screen that will be broadcast.

2.1.2 HDMI Channel

In addition to access to HDMI cameras or other HDMI interface devices, the first four channels can also be connected to IP cameras, Live+ devices, and network streams. Click the + icon to pop up the settings interface, as described in detail below:

Physical Input

Load the video and audio signals of the input interface into the corresponding channels, as shown in the following figure:

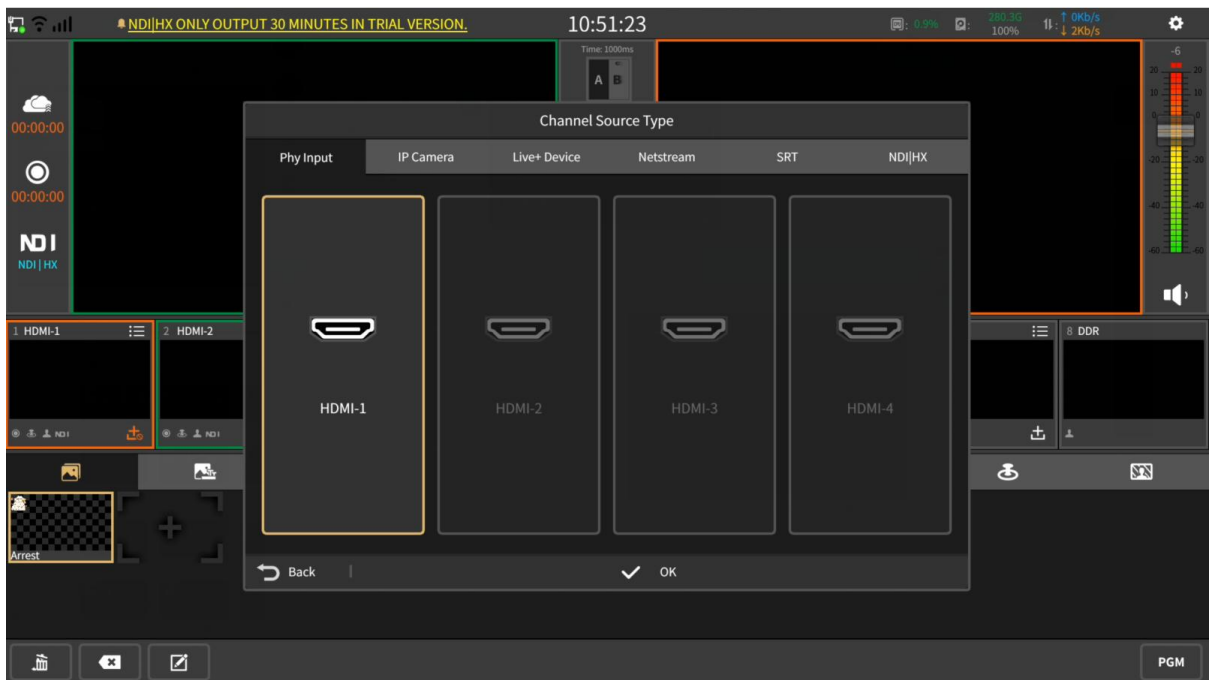

2.1.3 NET Channel

The NET channel is used to load network streams and the supported formats are: rtmp/rtsp. You can also directly load IP cameras, Live+ devices, NDI|HX.

- 1) Select the added IP camera in the list, click the "√" icon to confirm the selection, the setting interface is as shown in the figure below:

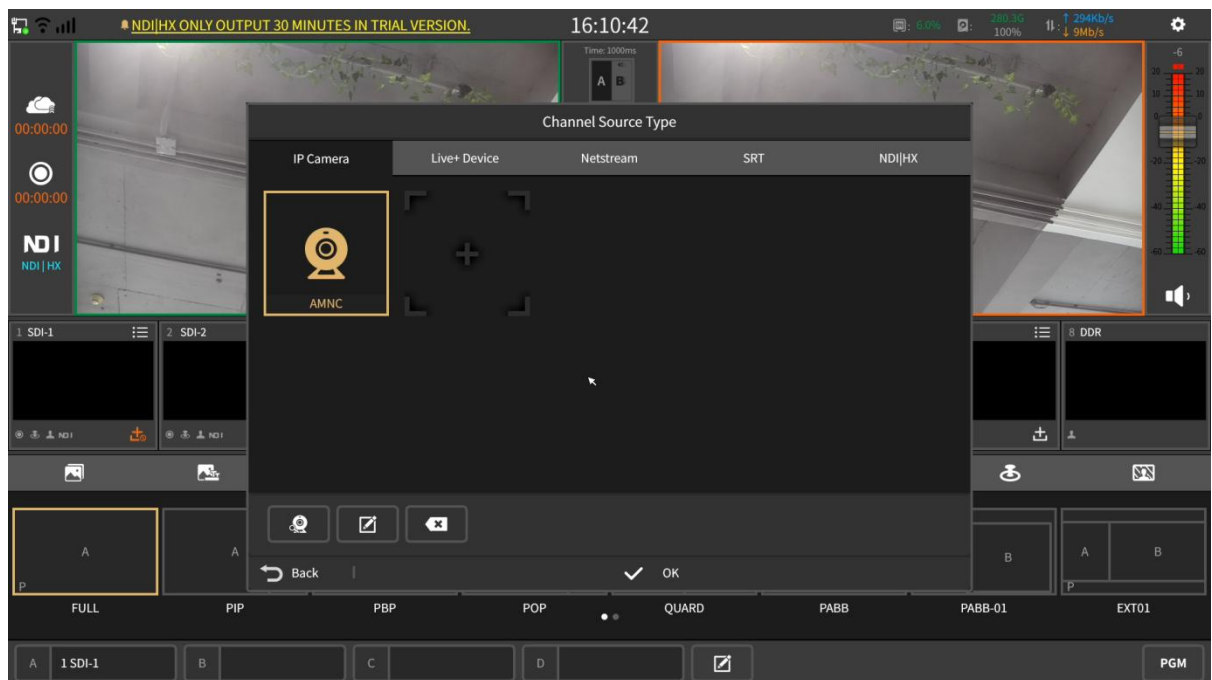

Click Add button or  button to enter the IP Camera add / edit interface to configure or modify the IP camera information, as shown in the following figure:

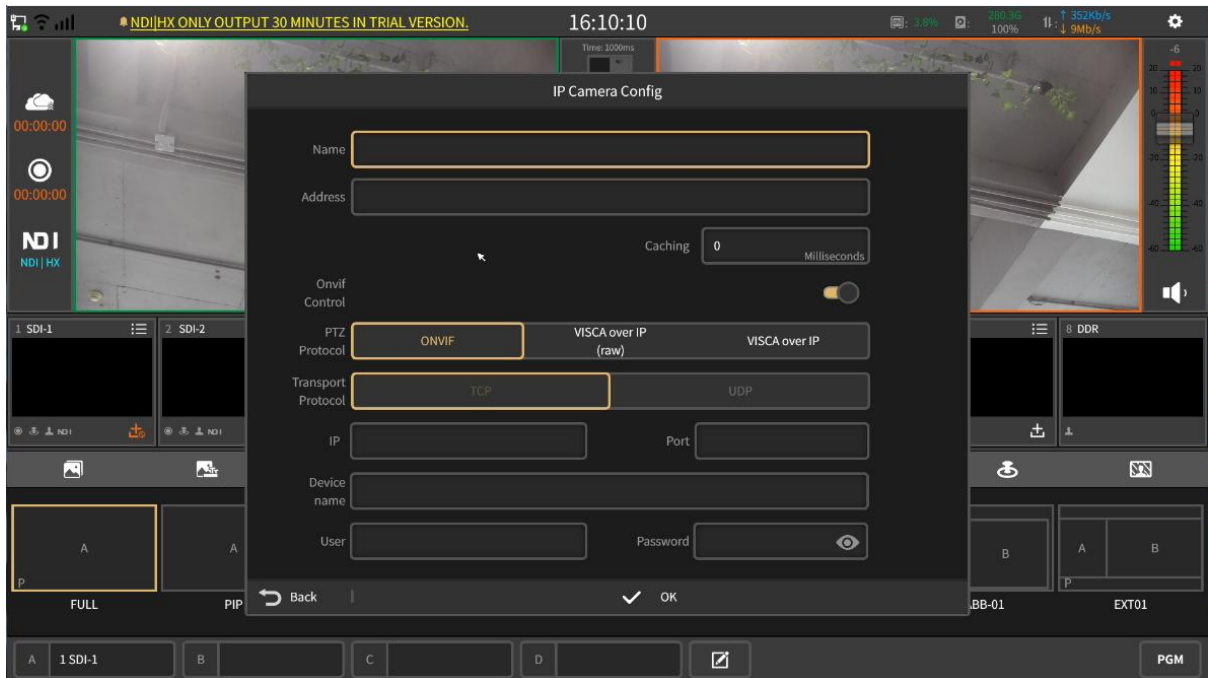

- 2) You can use the VJMobileCast app to access the mobile screen, both internal and external networks can be accessed.

The access signal can be accessed through the APP directly by scanning the QR code or entering the ID number. The access signal is displayed in the "Device List", click to select the signal screen that needs to be loaded to the mobile terminal. **(Note: The original ID is unavailable after resetting the ID, you need to re-scan the new ID)**

The setting interface is shown below:

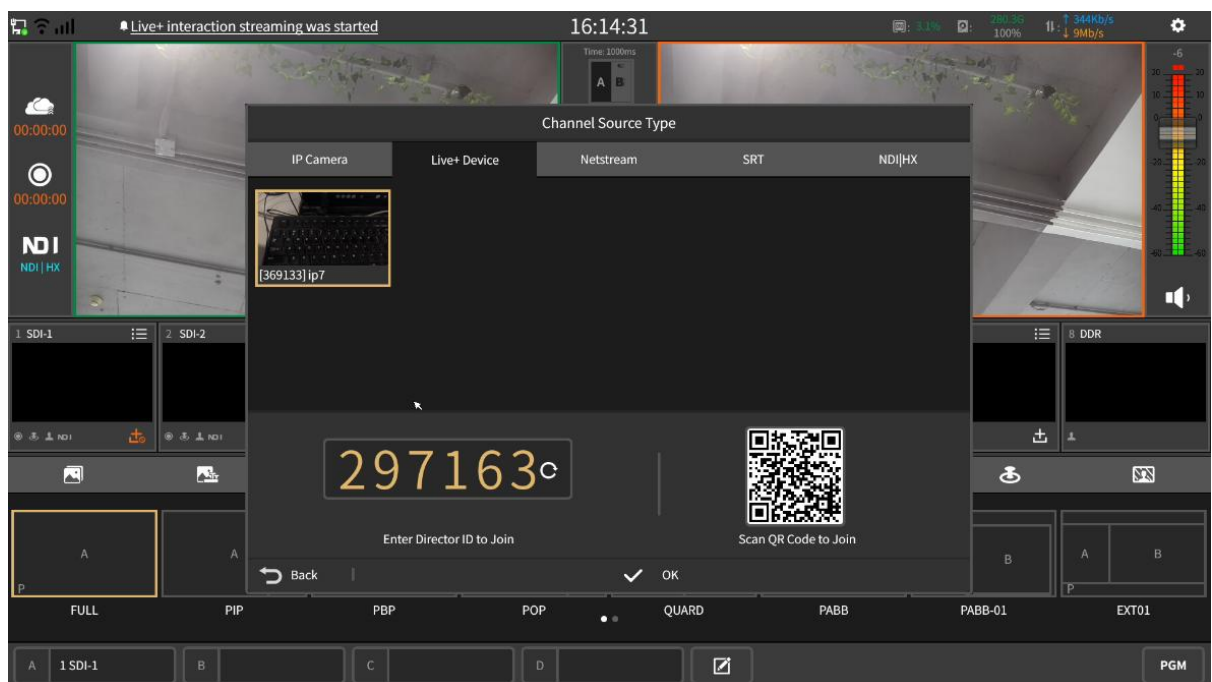

- 3) Click  to enter the network stream editing interface, fill in the complete network stream address in the URL, and use the same screen input function to quickly enter the stream address. As shown below:

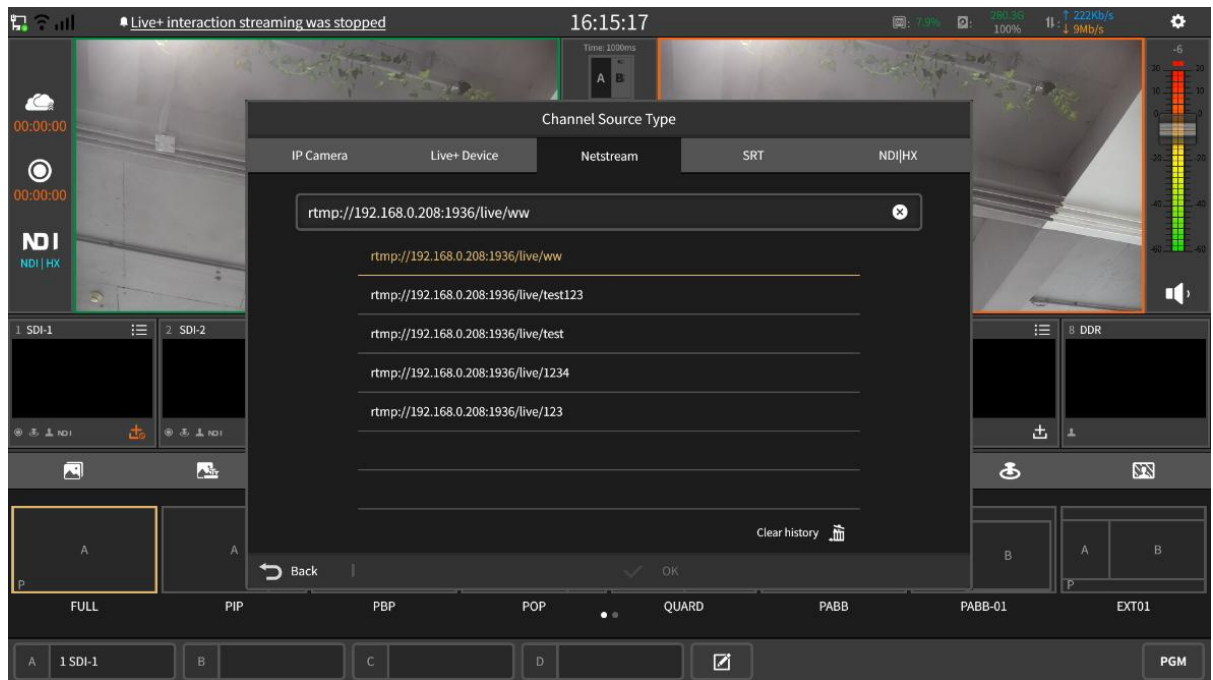

- 4) Click to enter the SRT stream editing interface and fill in the required content in turn. Here's what it looks like:

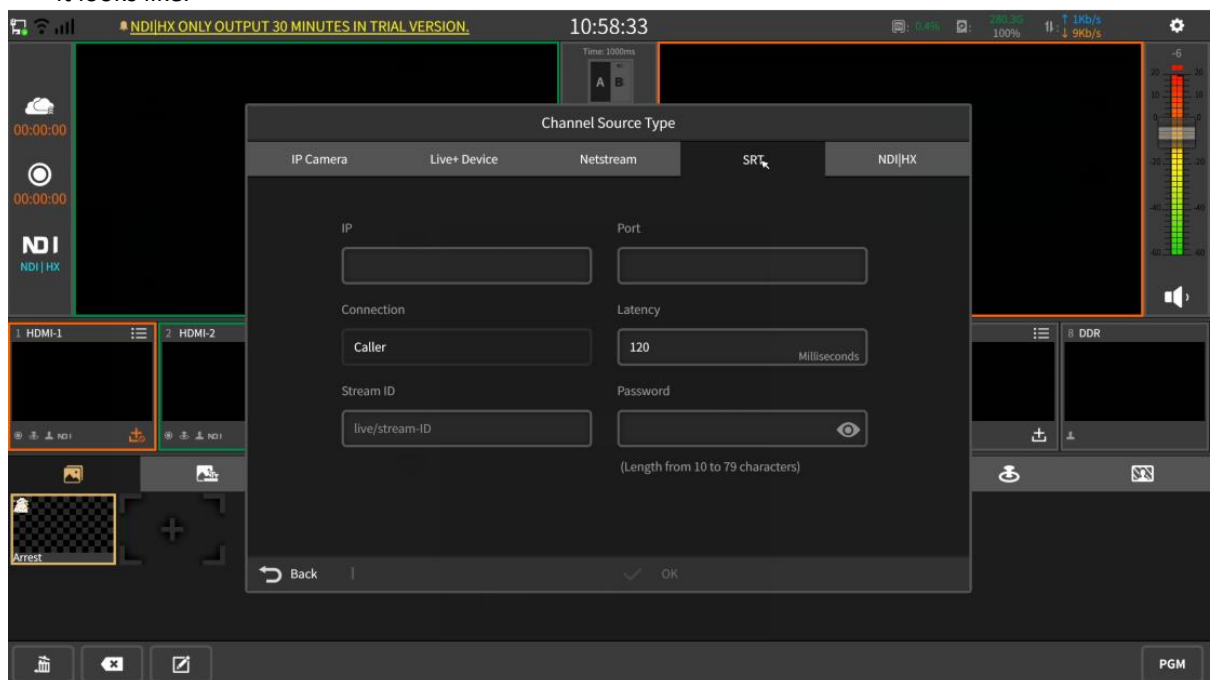

- 5) The NDI device in the LAN can be loaded, and it can be discovered automatically by clicking the refresh button, as shown in the following figure:





Note: This function need extra cost to enable.



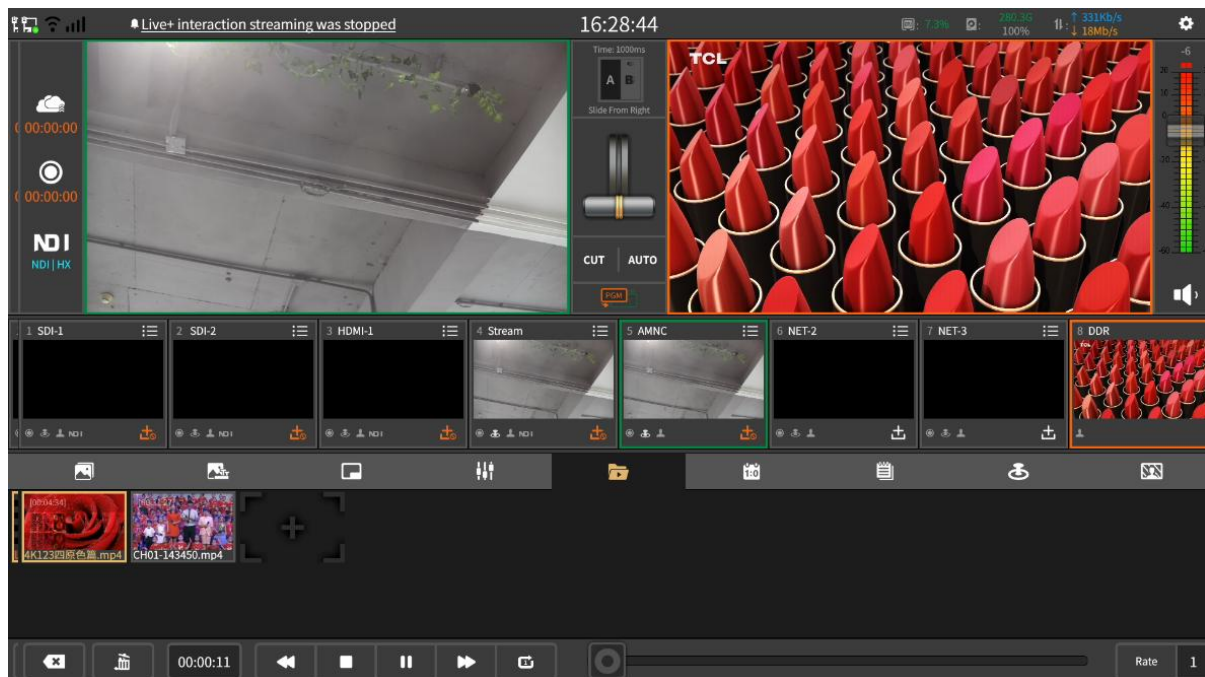







2.1.4 DDR Channel

The DDR channel is used to load video footage as shown below:



1) The button for loading video material is as follows:



- Button  : Add video
- Button  : Play/pause video

- Button  : Play
- Button  : Back 10 seconds
- Button  : Fast forward 10 seconds
- Button  : Stop
- Button     : Separately, play in list order, play single video loop, play in list loop and play single video
- Button  : The progress adjustment button is enlarged to adjust the video progress
- Button  : Select video and delete single video
- Button  : delete local video list
- Rate button: You can control the rate of playback.

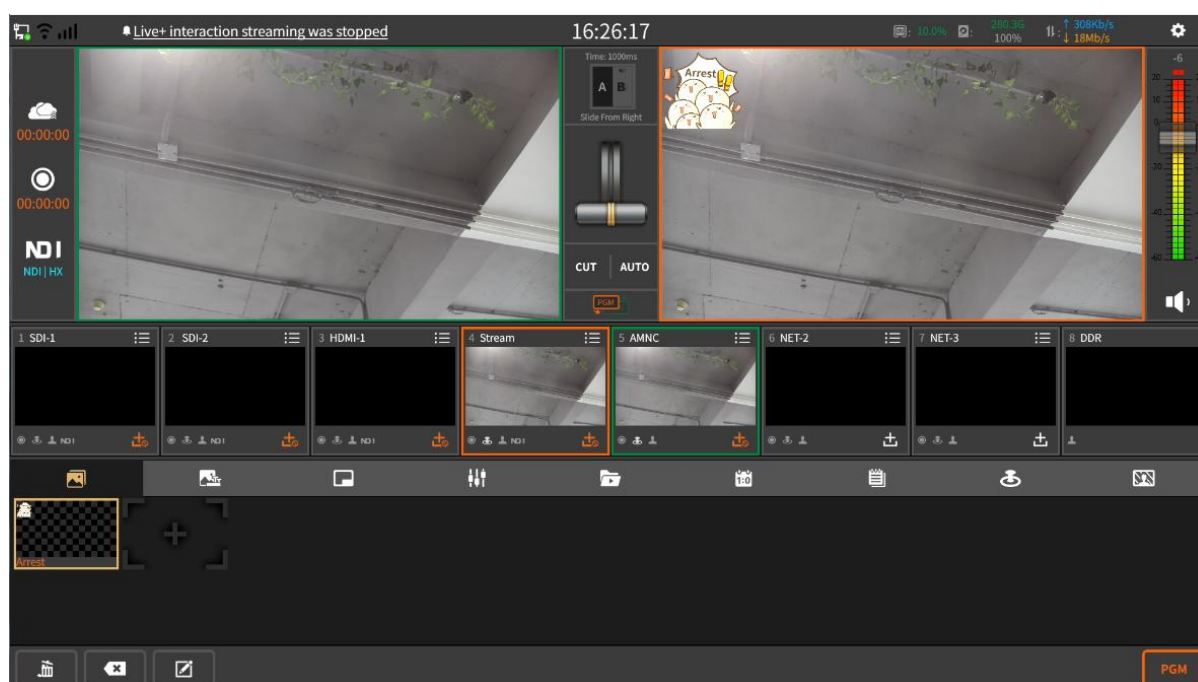

2.1.5 Image Overlay

Image overlay panel can publish image to the PGM monitor. It support png/jpg/jpeg/gif image format and location movement of images as shown below:



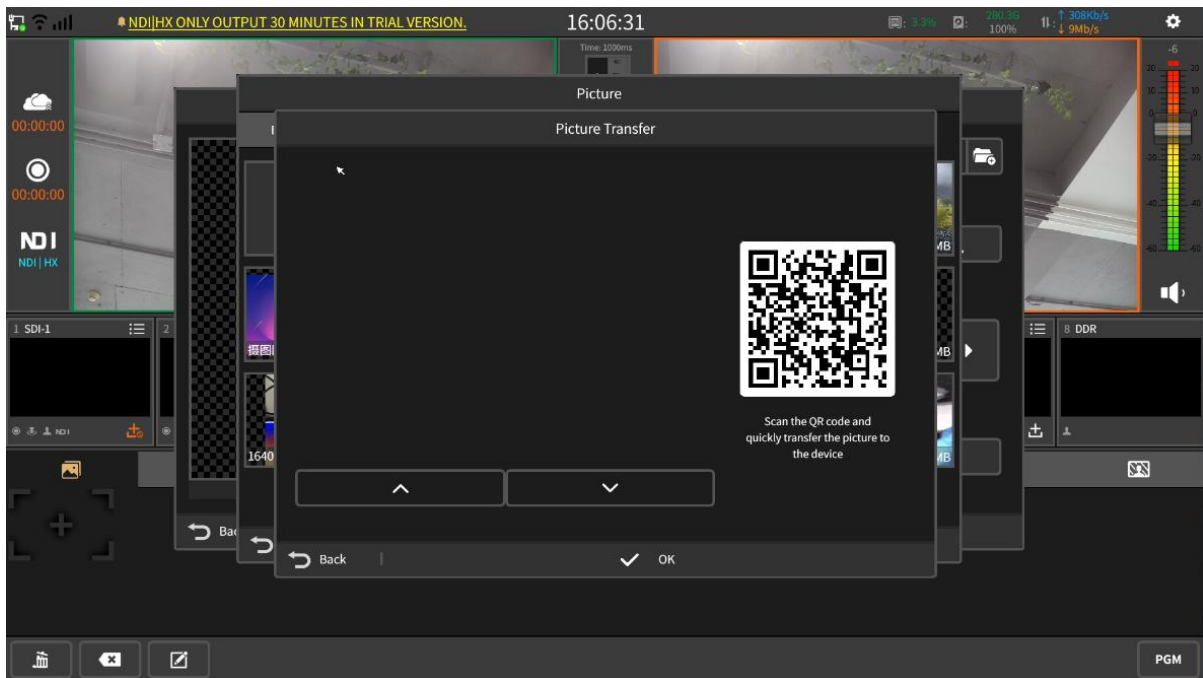



- 1) Click the button “” to enter the photo editing interface, and then click the button “” to add a picture. There are two ways to source images:
 - Online download. Click "Download" to download.
 - Customize “My Picture”. You can copy the picture to the “My Pictures” folder which located at the “File Transfer” interface as shown below:

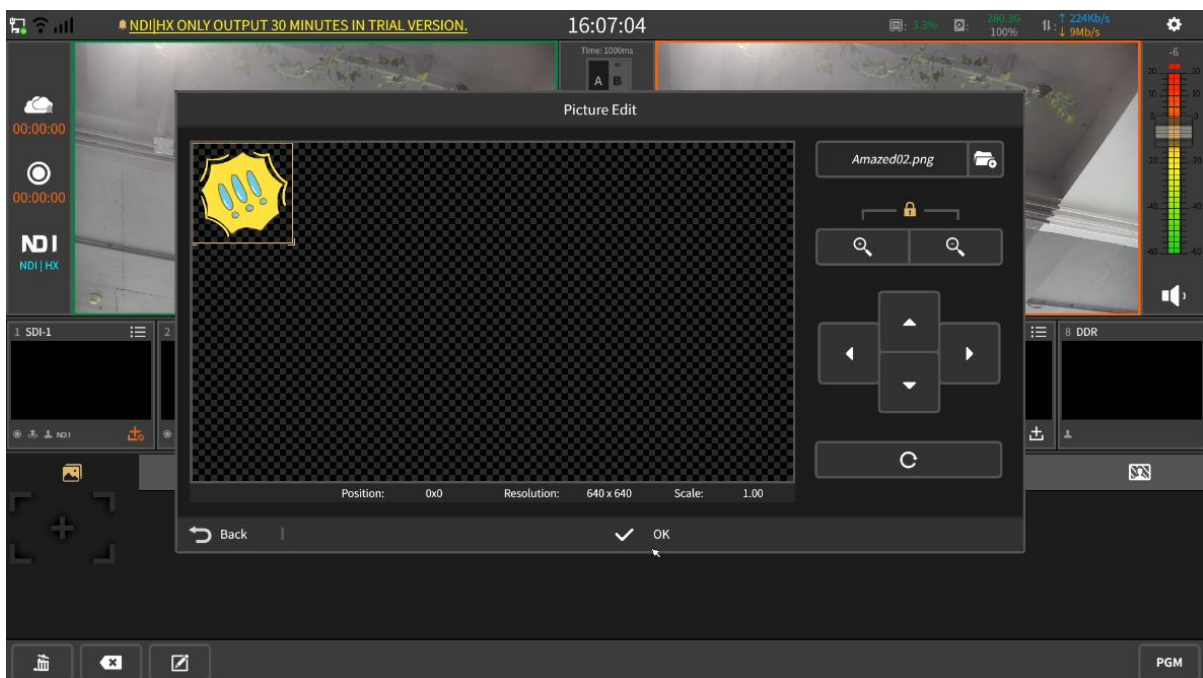



- 2) Click  to send it to the PGM, and click again to not display.
- 3) Click  to enter the photo editing interface. In the picture editing, you can drag and drop the picture manually to adjust the position and size of the picture, as shown below:



Button operation is as follows:

- Four button  : Adjust the position of the picture in the up, down, left, and right directions
- Button  : Zoom in
- Button  : Zoom out
- Button  : Restore image to initial state

- Button : Select picture and delete single picture
- Button : Select the image and click to delete the image list

2.1.6 PIP (Picture in Picture)

Picture-in-picture can display multiple channels on the PGM channel. Click  to display the selected picture-in-picture mode in the PGM channel, where A/B/C/D represent the screen of the channel. The channel screen of A/B/C/D area on the PGM channel supports real-time switching. The picture-in-picture template is divided into the following two types:

- 1) No background image template as shown below:

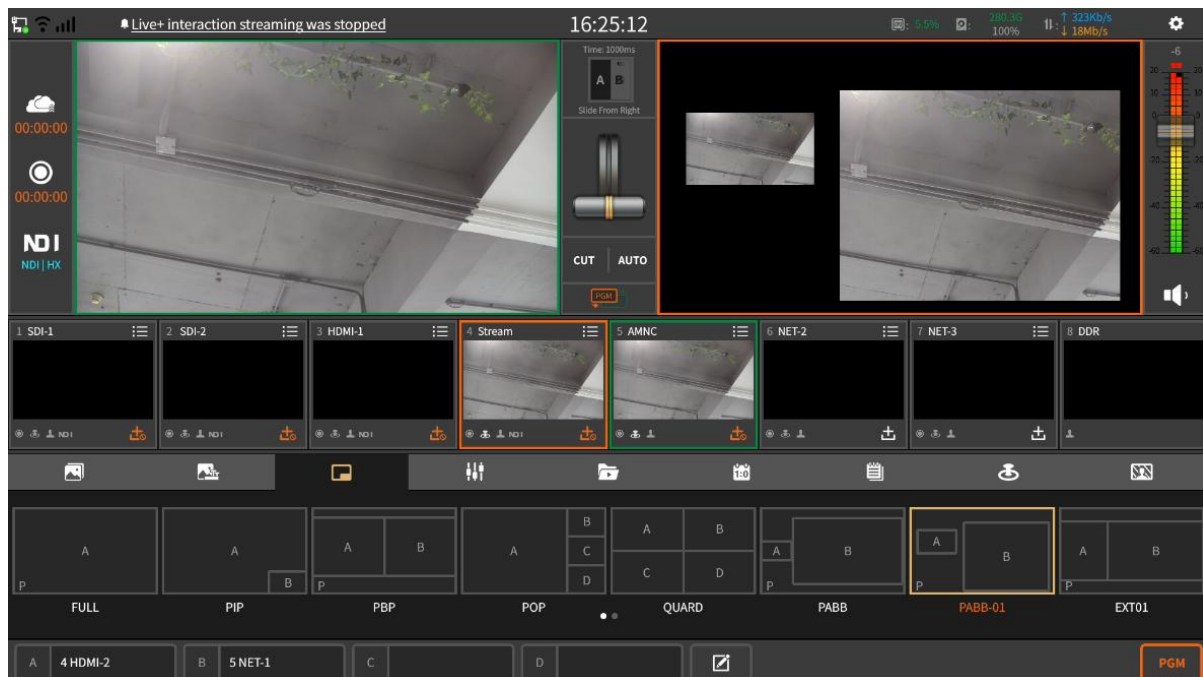

- 2) Add background image template. The background image is stored in the "picture material" folder of the "file copy" interface. Click the "configuration" button to edit the picture in picture, including changing the background image, stretching and clipping the picture, changing the size and position, and cutting the channel picture freely.

Click on the  button to quickly add a background image using a picture fast scan code. You can edit the picture in the picture by changing the background image, stretching and clipping the picture, and changing the size and position, as shown in the following figure:

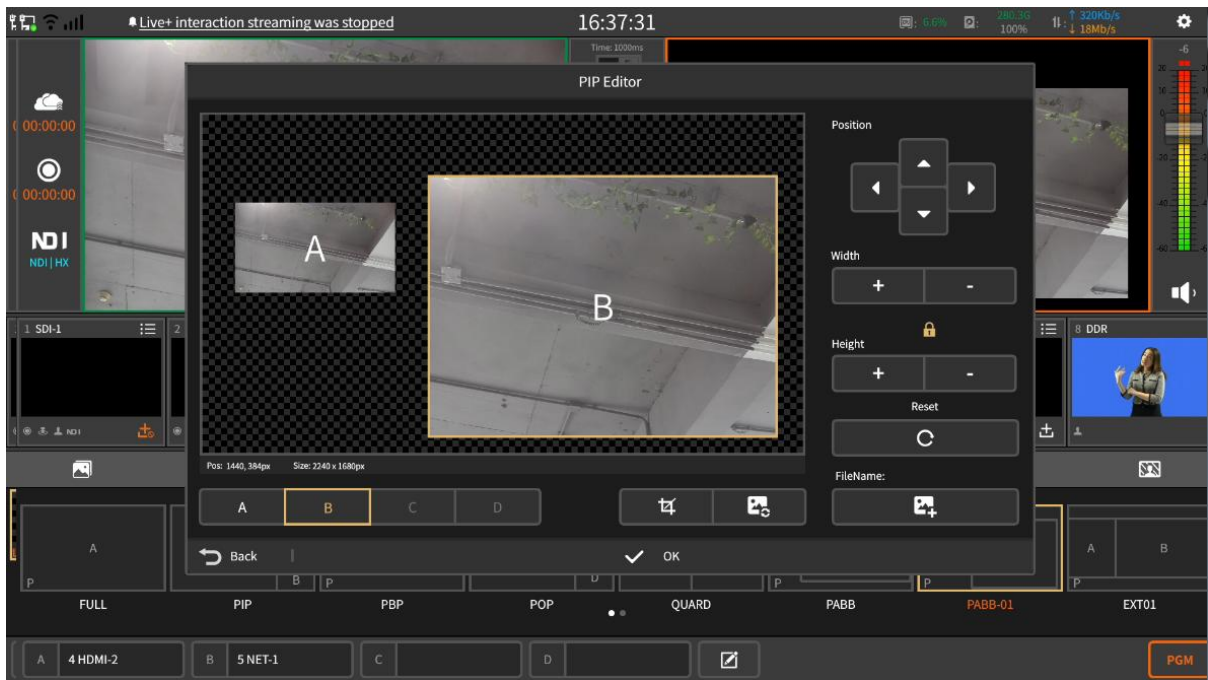

2.1.7 Scoreboard

The scoreboard can record the score of the live match in real time as shown in the figure below:

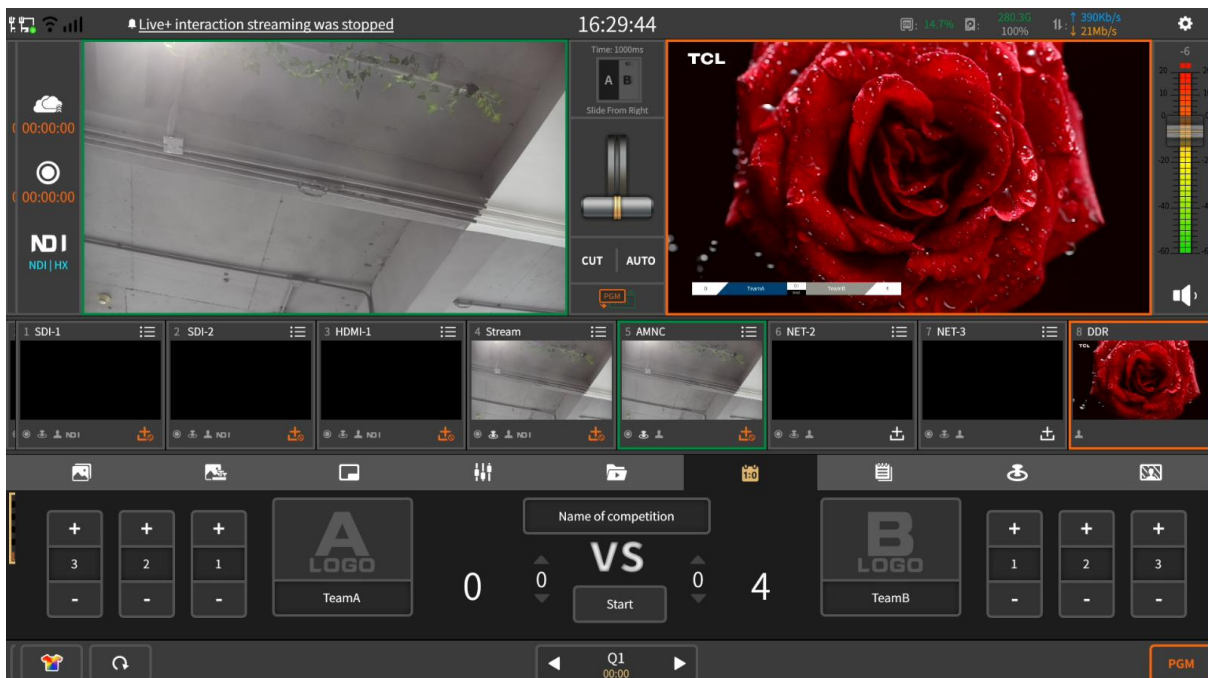

1) Button operation is as follows:



- Button **PGM** ↑: Display the score board to the PGM channel and click again to cancel the display.

- Button  : Choose the template of the scoreboard. The templates are general, basketball, football, table tennis, ice hockey and volleyball. You can also select "my scoreboard" to customize the scoreboard. You can import the scoreboard material in "Settings - File copy - Scoreboard material" to use.

2.1.8 Audio Mixer

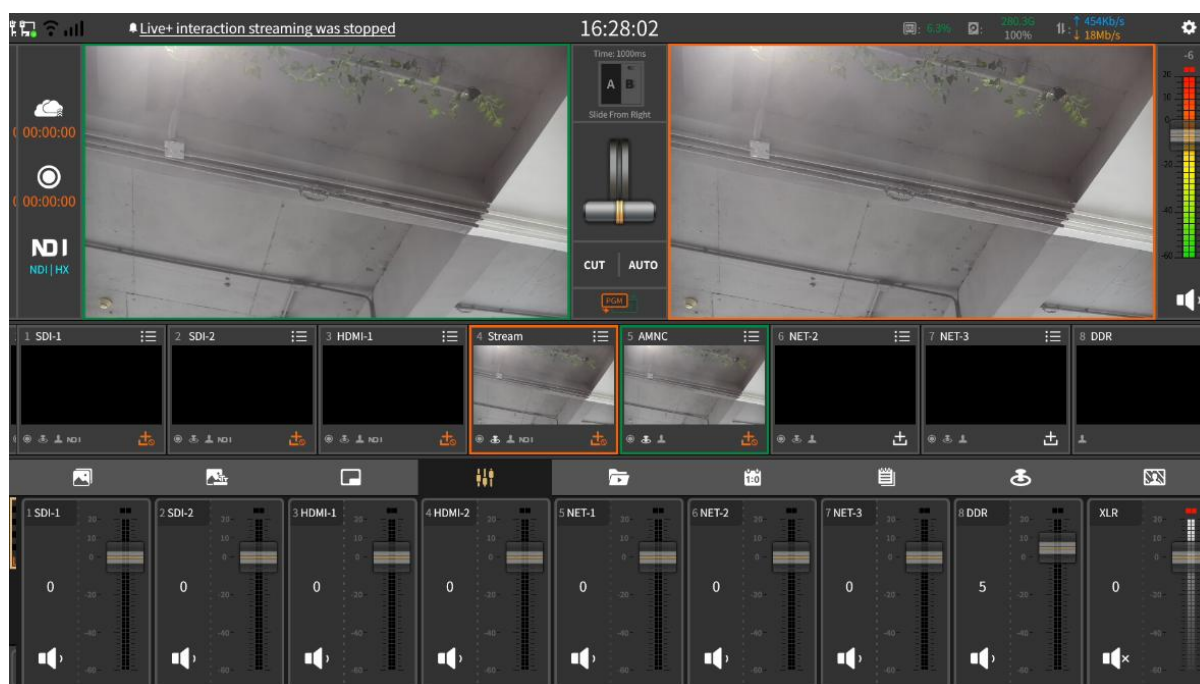
The mixer is used to control the gain and mix of all input and output audio as shown below:



- 1) Button operation is as follow:
 - Button  : Mixing output.
 - Button  : Mute.
 - Button  : Volume adjustment fader.





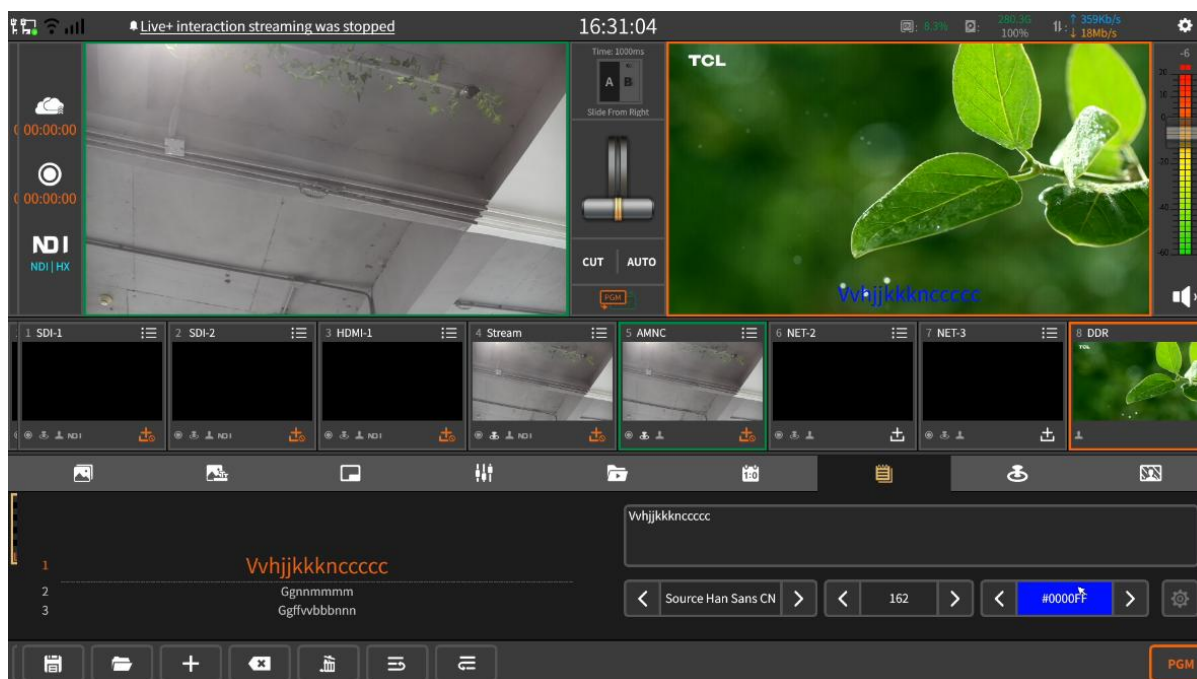

2.1.9 Subtitle

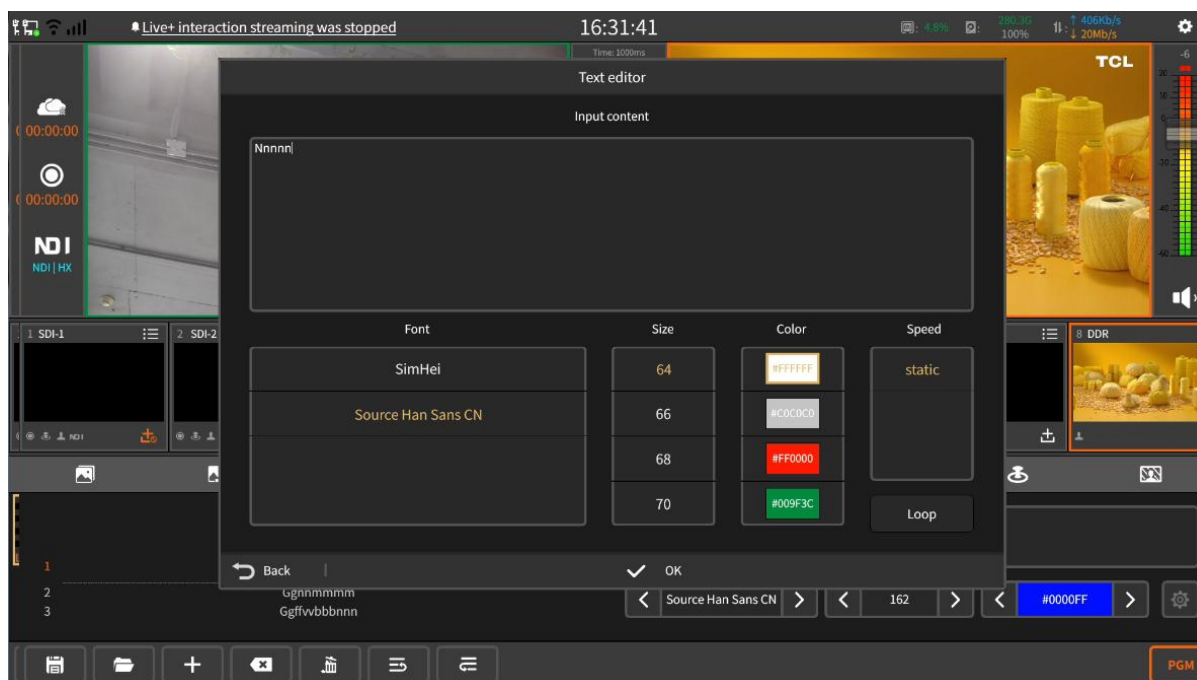
You can upload simple subtitles to the PGM by manually inputting subtitles or import txt file. The subtitle panel interface is as shown below:



- 1) Click  button to manually enter the subtitles. In the input content, you can adjust the font type, size and use three parameter values as required. The figure is shown below:



- 2) Click  button to export the subtitles
- 3) Click  button to Import txt file
- 4) Click  button to delete the selected subtitle.
- 5) Click  to clear all the subtitles
- 6) Click  to move up the selected subtitle
- 7) Click  to move down the selected subtitle



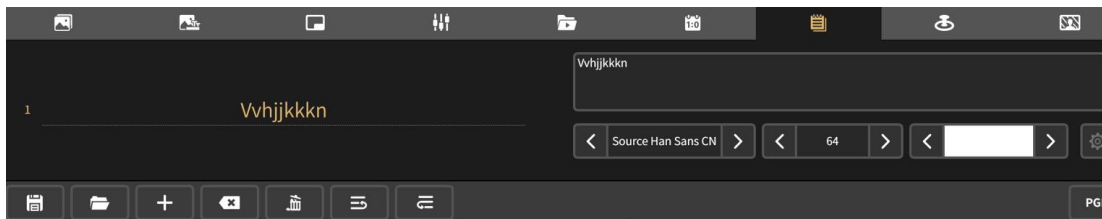

8) Subtitle editing: select the subtitle to be edited, and directly modify the text content, font type, size and color in the right text box, as shown in the following figure:

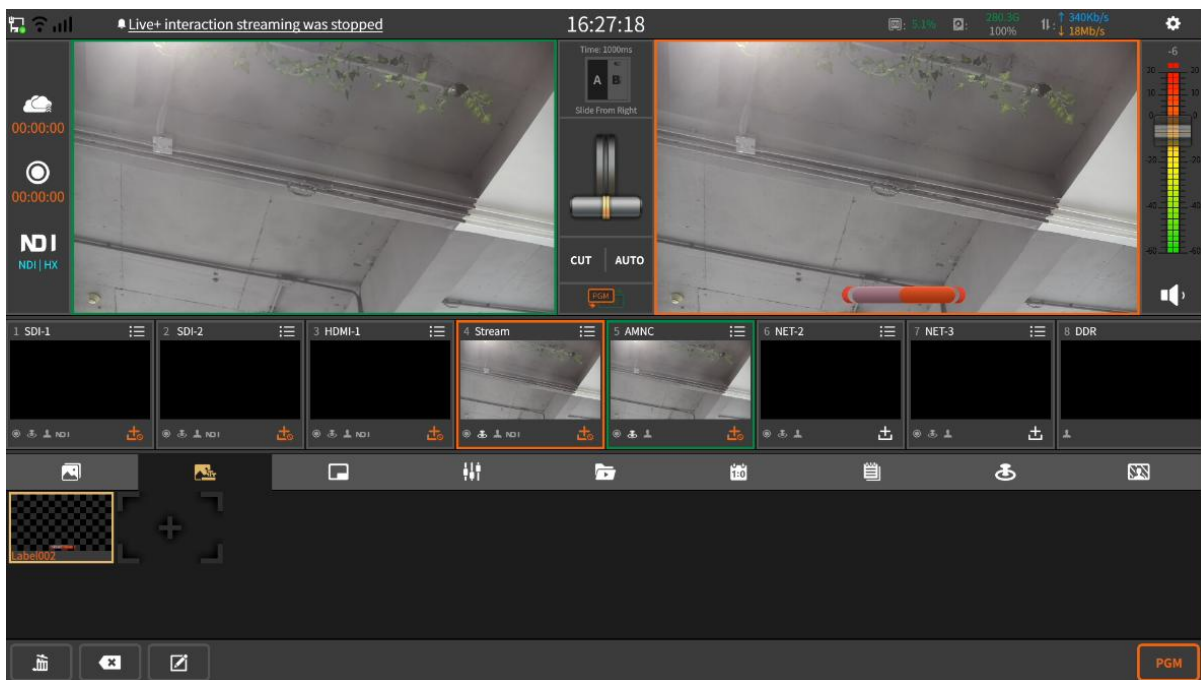

2.1.10 CG

CG is a template composed of pictures, texts, etc. It can be used during live broadcast or recording. The interface is as shown below:



- Click  to create CG.
- Click  to delete single CG
- Click  to edit the selected CG.
- Click  to delete all CG list.

In the CG editing interface, you can choose to add CG template/picture/subtitle, you can manually adjust the parameters of each element including size, position, etc. The editing interface is shown below:

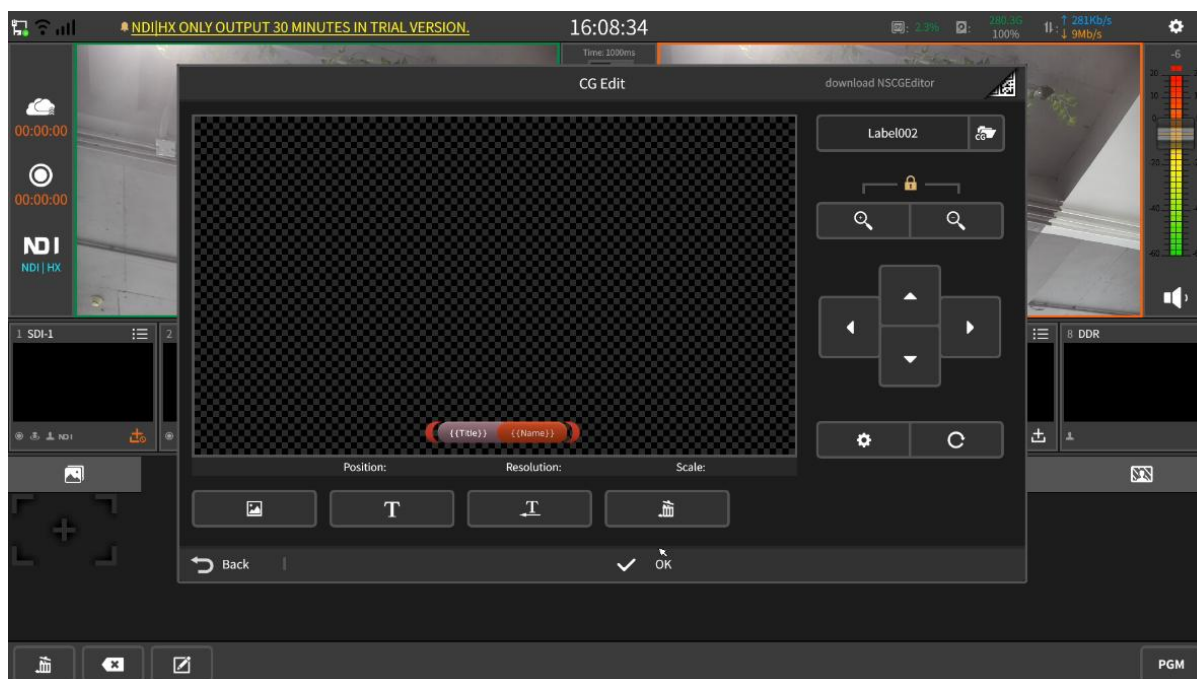

There are several ways to add CG templates:

- 1) Click "download" to use;
- 2) Import custom material in "Settings - File - File copy - CG material". You can use custom template in "My CG".
- 3) Click the QR code at the top right of the CG editor to download the CG editor NSCGEditor, and start the remote CG in "setting -Overlay - Remote" to realize online CG, as shown in the following figure:

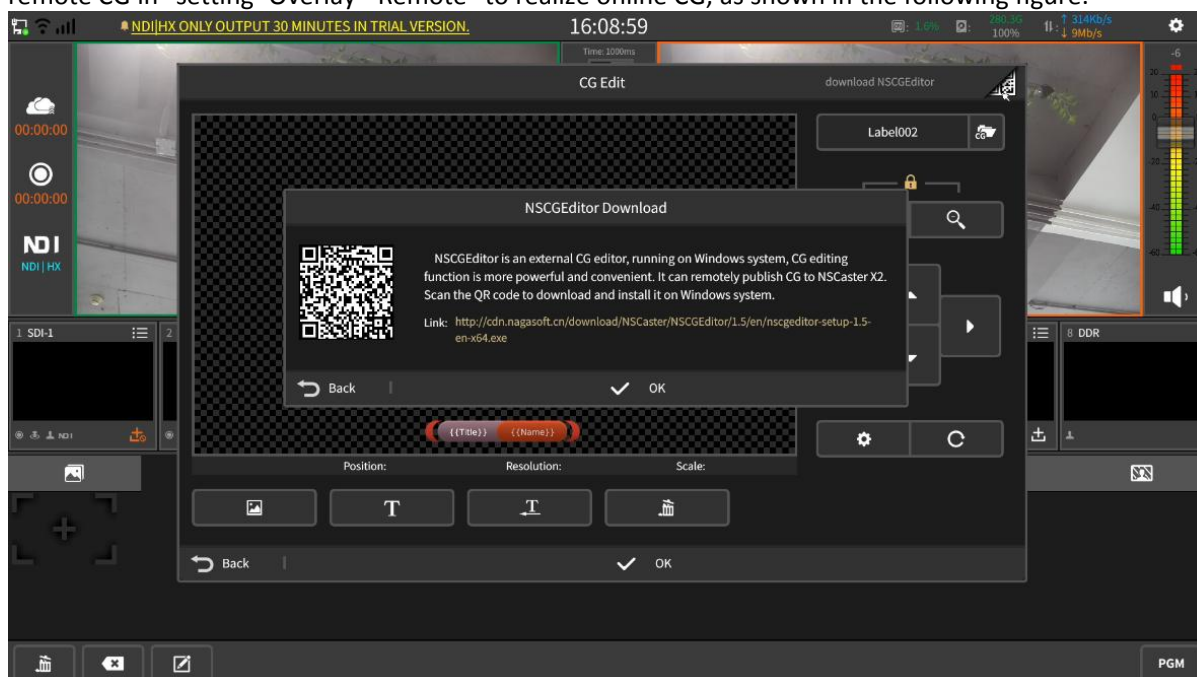

2.1.11 PTZ control

Select a channel to load the IP camera or NDI | HX device to control the camera, as shown in figure:

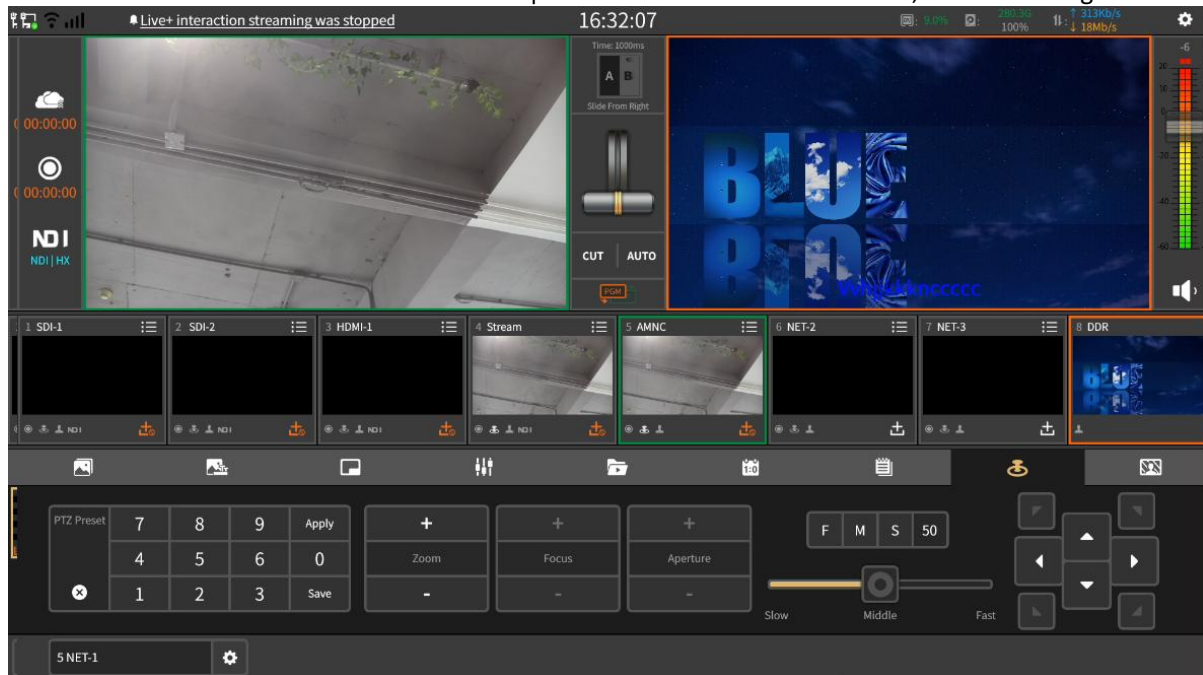

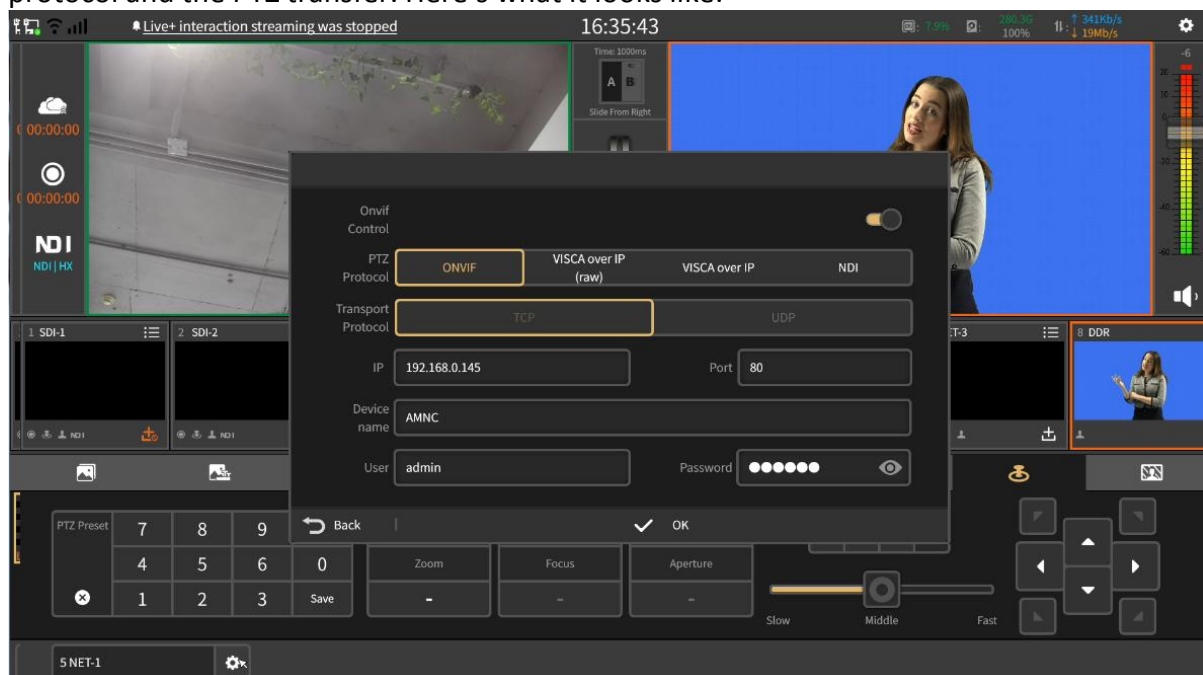

1) PTZ protocol: Click the  button to turn on the PTZ control interface to set up the PTZ protocol and the PTZ transfer. Here's what it looks like:



Note: the IP camera must correctly input IP address, port, user and password of the camera to control. The NDI protocol must be enabled in the device information interface in settings then NDI | HX can be used.

2) Preset position: set the camera's preset position by entering a number and then saving it. Enter the saved preset, and then call.

3) Zoom: Click on the  button above to zoom in. Click on the  zoom button below to zoom out.

- 4) Direction control: The direction of camera movement can be controlled by up, down, left, right, the upper left, the upper right, the lower left and the lower right.
- 5) Speed adjustment: drag the speed adjustment button **F** **M** **S** to control the camera screen movement speed.
- 6) Channel selection: select in the need to control the channel, the PTZ selection channel and the camera loading channel should be consistent.

2.1.12 Special Effects

Select the special effects required for the screen switching between the PVW channel and the PGM channel, and set the duration of the special effects switching process - transition time. You can select to click **CUT** or **AUTO** button to switch the screen between the PVW channel and the PGM channel, and you can also use the special effects pusher to switch to achieve the transition effect. The setting interface is shown below:

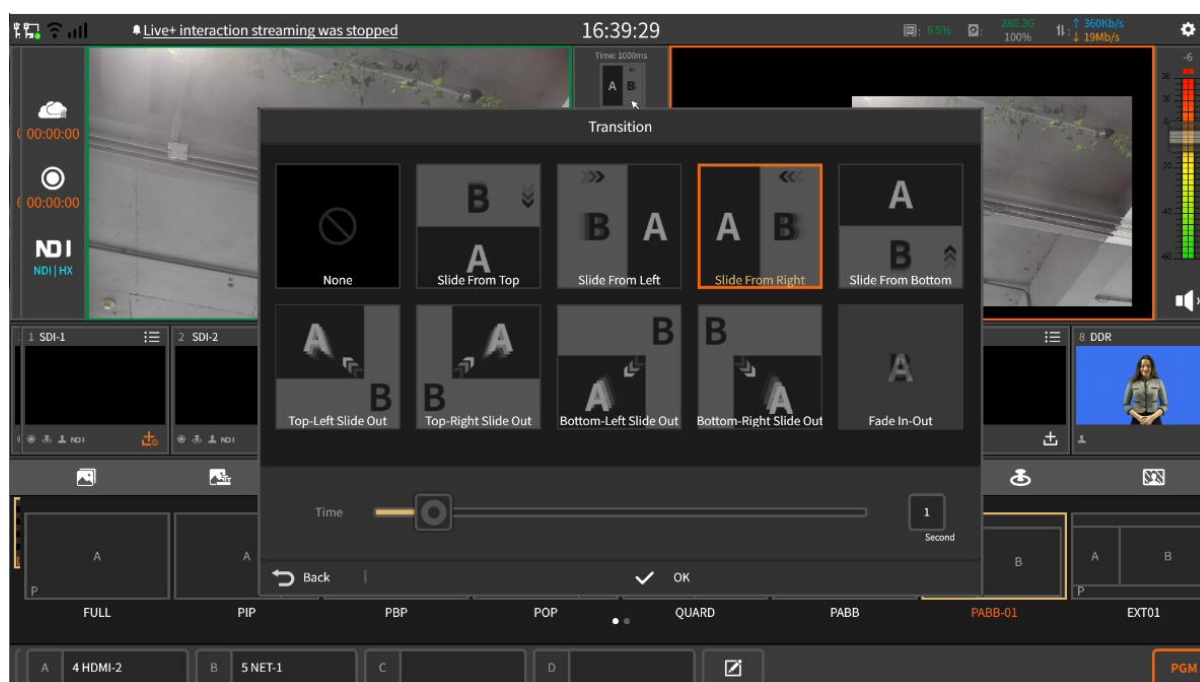

2.1.13 Chroma key

Chroma key is mainly used to eliminate the blue / green background behind the character background, and superimpose a specific virtual scene or specific background. Multi channel chroma key is supported in NSCcatser X2, and the effect is shown in the following figure:

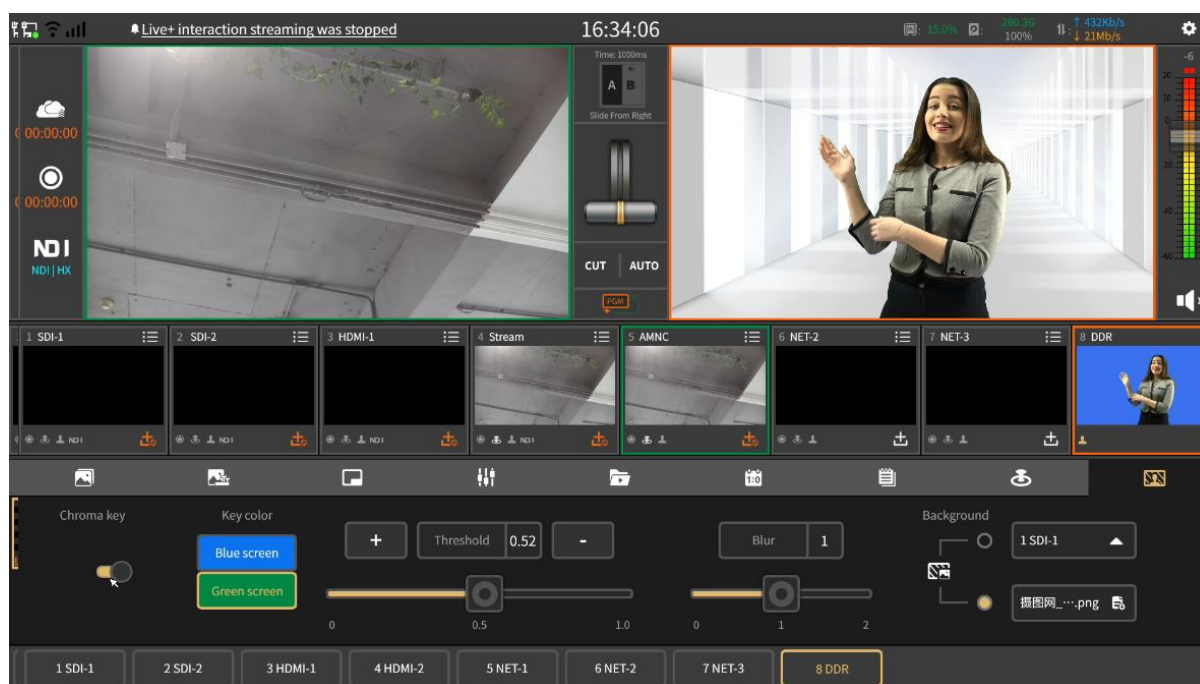

Chroma key instructions are as follows:

- 1). Select the channel to enable chroma key, and the channel loads Chroma key materials;
2. Adjust the threshold and blur to achieve the best chroma key effect;
3. You can use other channels as the chroma key background, or use a custom background image. When the selected channel has no content, the chroma key background is transparent.

2.2 NSCaster-X2 Settings Interface

Click  to enter the setting interface. Respectively, there are "Project, Recording, Streaming, Output, NDI|HX output (if the module enabled), Network, Audio settings, OSD settings, File Transfer, General Settings, About" module.

2.2.1 Project

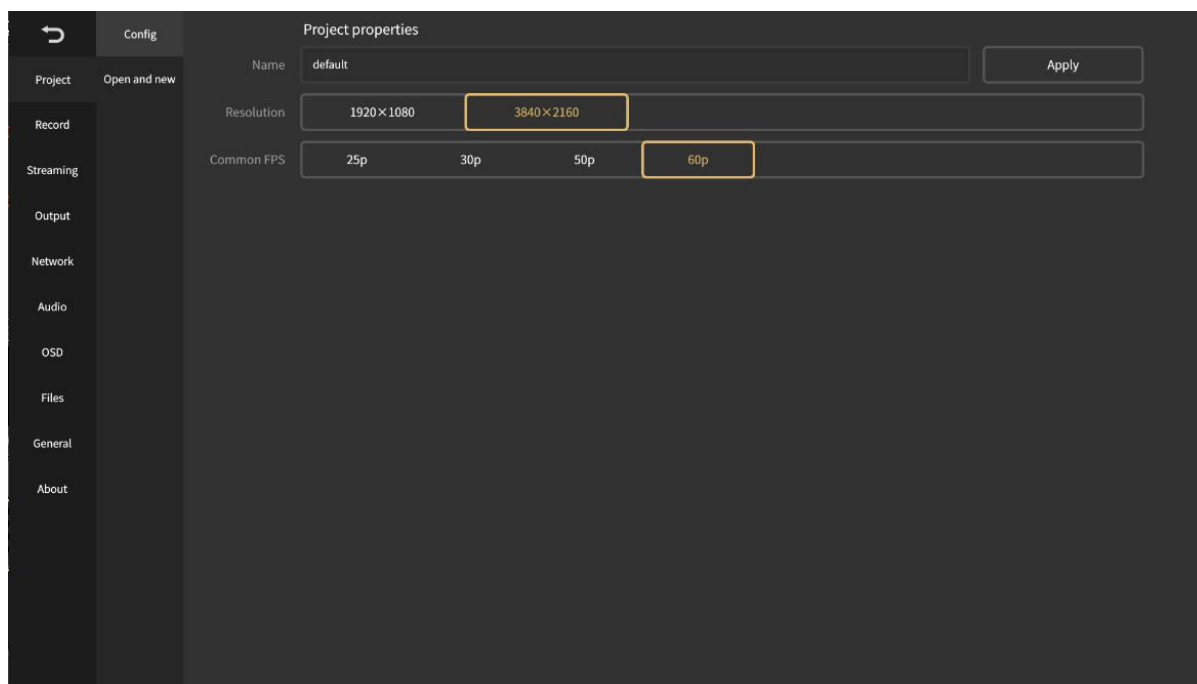

Open the project module. By default, the project attribute displayed is the current project resolution. You can also click the required resolution and fps, select it, click apply, and restart the device. The configuration interface is shown in the following figure:

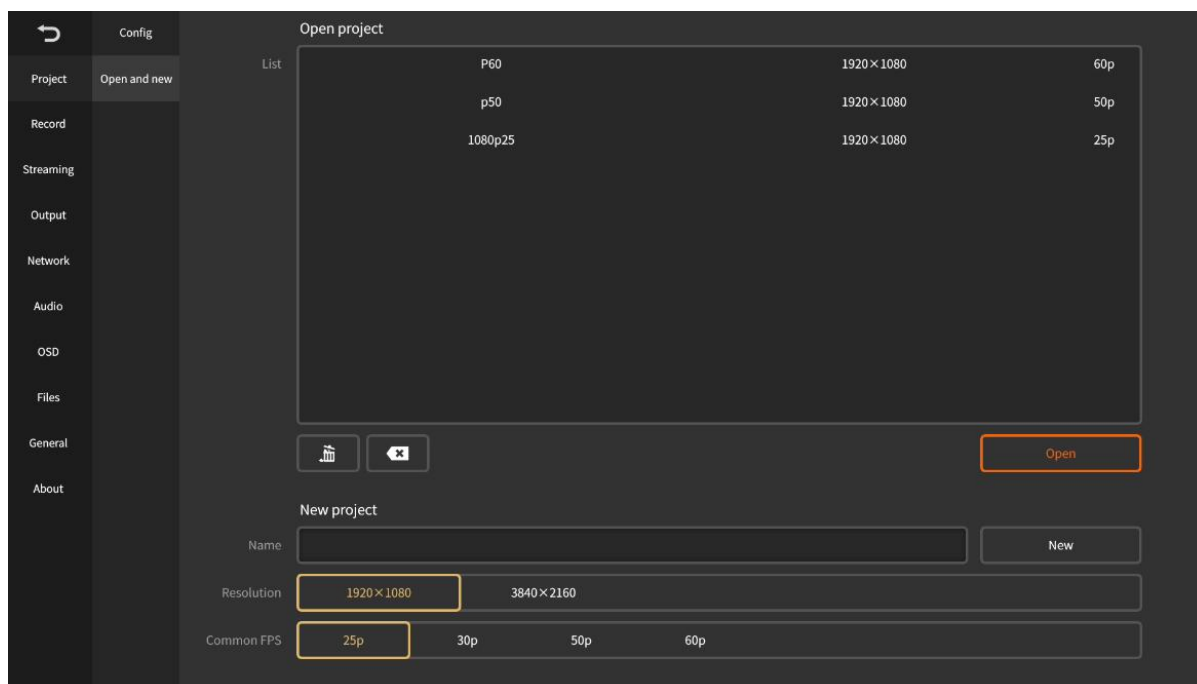

Open and create new module: you can select the recently opened historical project or create a new project. After saving, you can directly select the project to open the next time. The interface is shown in the following figure:



The button operation is described as follows:

- 1)  Button: delete a single project;
- 2)  Button: clear the project list.

2.2.2 Recording

Record is including the PGM recording and channel recording. Click the button  on the “Main Interface” to start recording, and click again to stop. The recorded files are stored in the “Record-File copy-Recording” folder. The interface is shown as below:

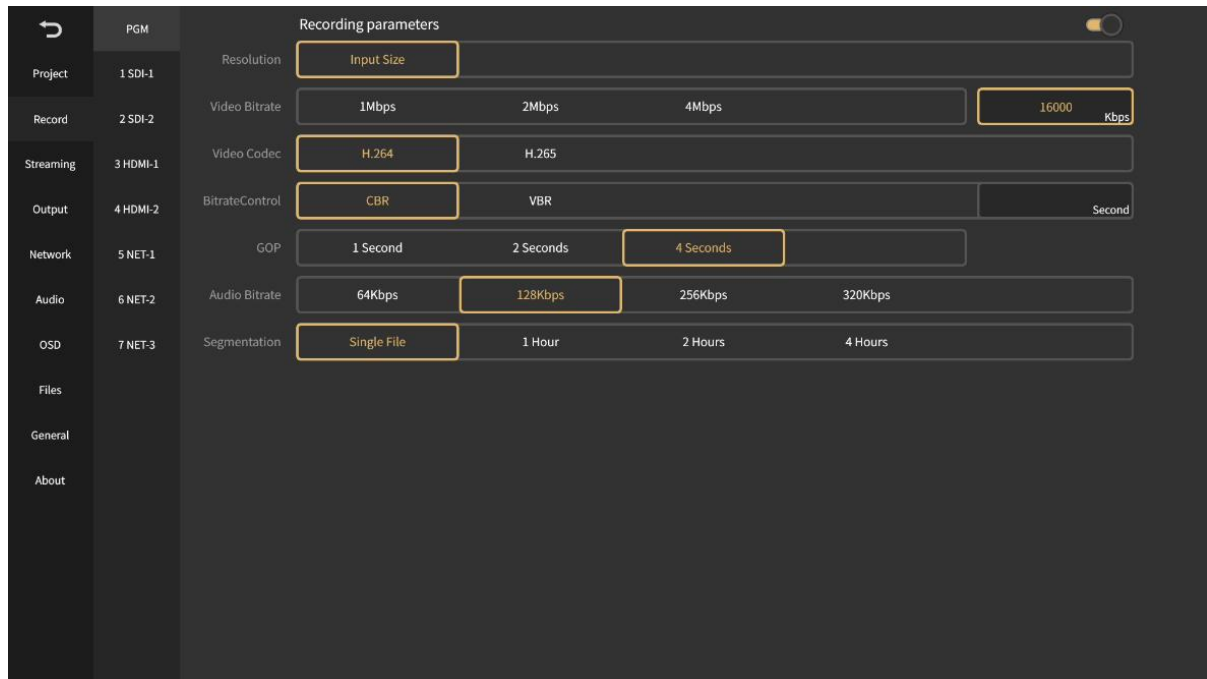

PGM recording can be started independently. When channel recording is started, PGM recording must also be started.

Note: If the recording is interrupted in the middle, the file will be damaged and you need to use the repair tool to repair the recorded file. To reduce the damage of the whole file caused by recording interruption, you can choose to split the recorded file.

Parameter settings include: resolution, video bitrate, video codec, bitrate mode, GOP, audio bitrate and segmentation. The bitrate and GOP in the interface can be customized.

2.2.3 Streaming

PGM streaming is through RTMP protocol for live streaming. Click the button  on the “Main Interface” to start the streaming and click again to stop, settings as shown below:

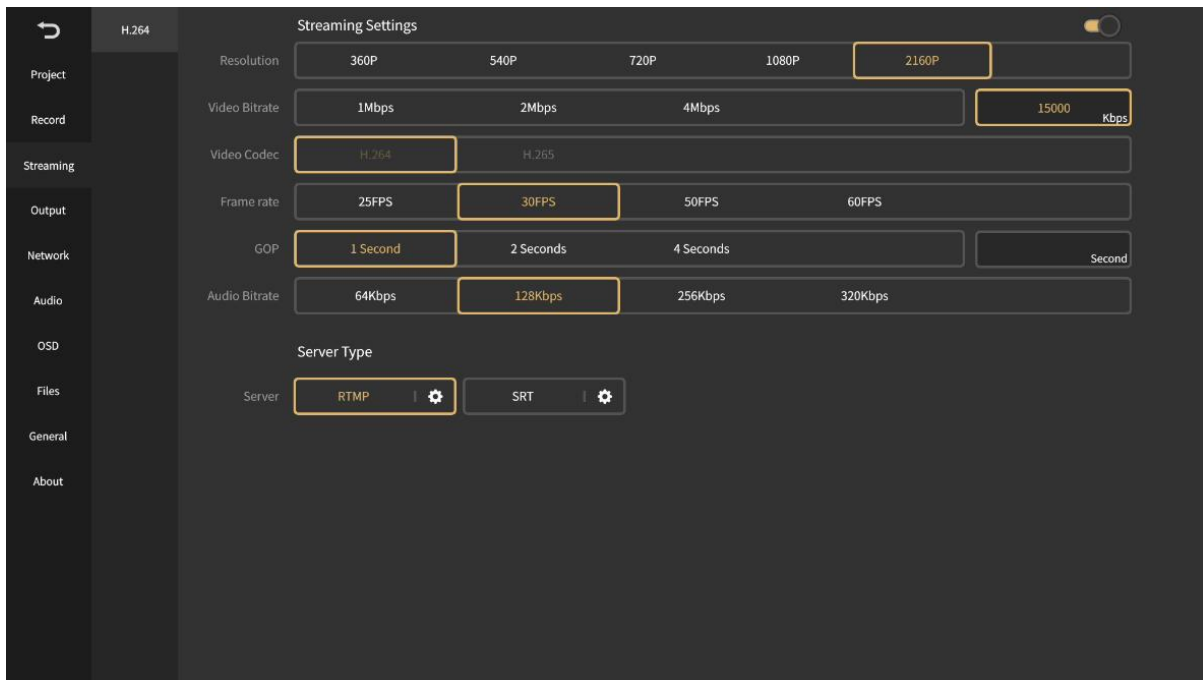

Streaming parameter settings include: resolution, video bitrate, video codec, frame rate, GOP, audio bitrate. The bitrate and GOP in the interface can be customized.

Streaming mode: RTMP

Select the live streaming as "RTMP", which can be pushed to two streaming media servers at the same time. If streaming protection is set, the user name and password must be entered. If there is not required, it does not need to be filled in. Input format is "rtmp://ip:port/live" Stream name is the name of the channel. Enter the complete streaming address in RTMP address 1 or RTMP address 2. As shown in the following figure:

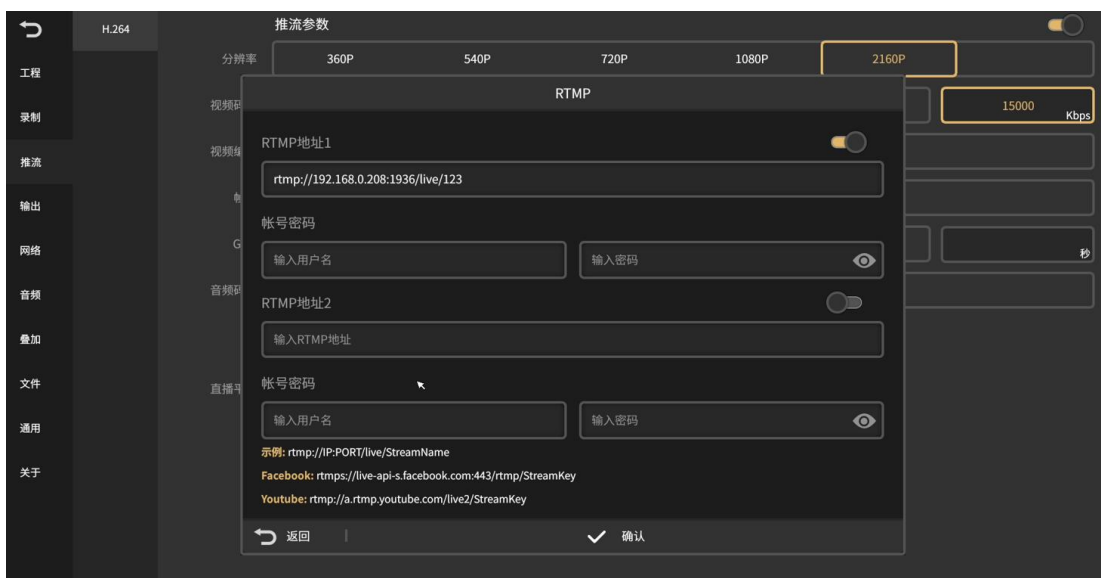

2.2.4 Output

1) NDI|HX output

This module needs to be paid to add. This feature is available when NDI|HX is activated in the device information interface. You can choose NDI output source, resolution, video bitrate, video codec, GOP, audio bitrate. After NDI | HX is enabled, no channel is selected, and PGM content is output by default as shown in the figure below:

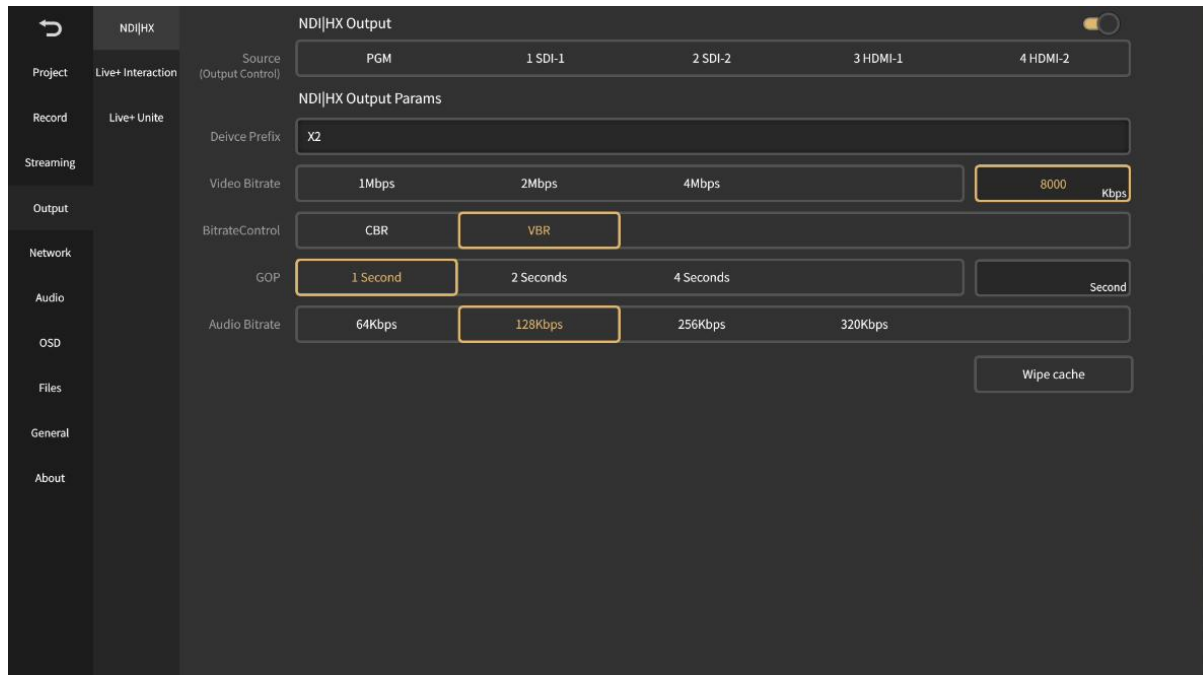

2) Live+ interaction

It is used to set the parameters of interactive video and audio to be output when it is used as an interactive source, mainly including the settings of video source, audio source, video resolution and audio bit rate; If a live+ service is deployed in the LAN, you can customize the server and port for interaction, as shown in the following figure:

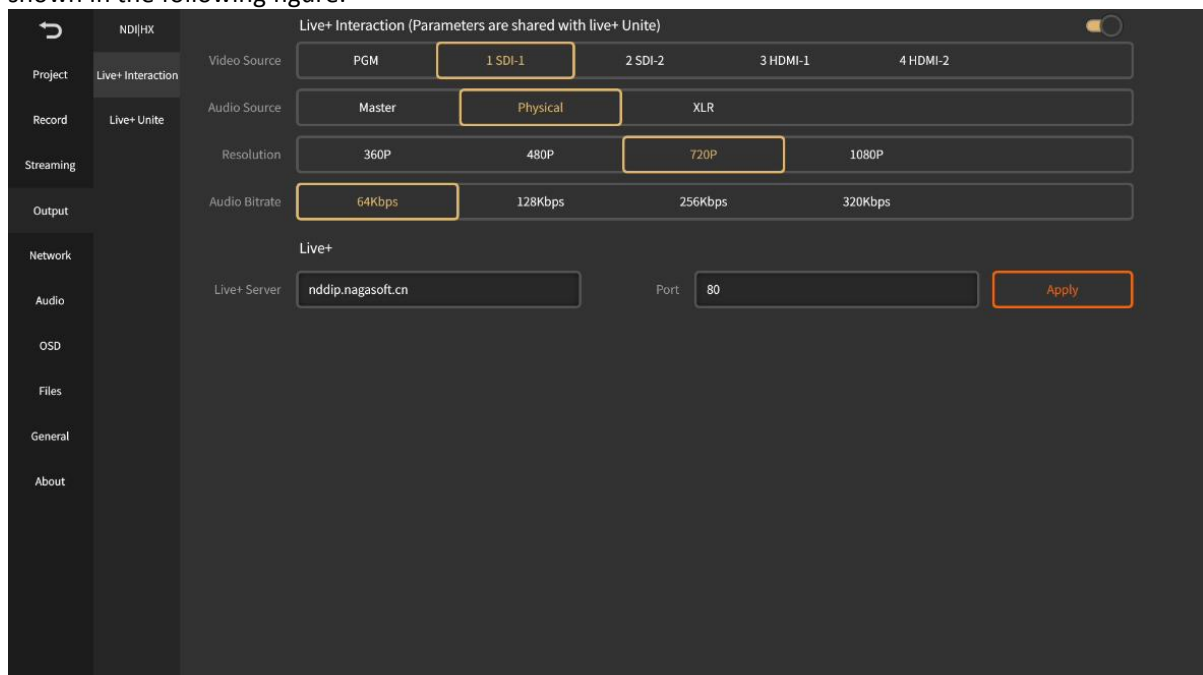

3) Live+ Connection

To connect to the host venue, first you need to know the director code of the host venue equipment, and then select the host venue image on the equipment when connecting, as shown in the following figure:

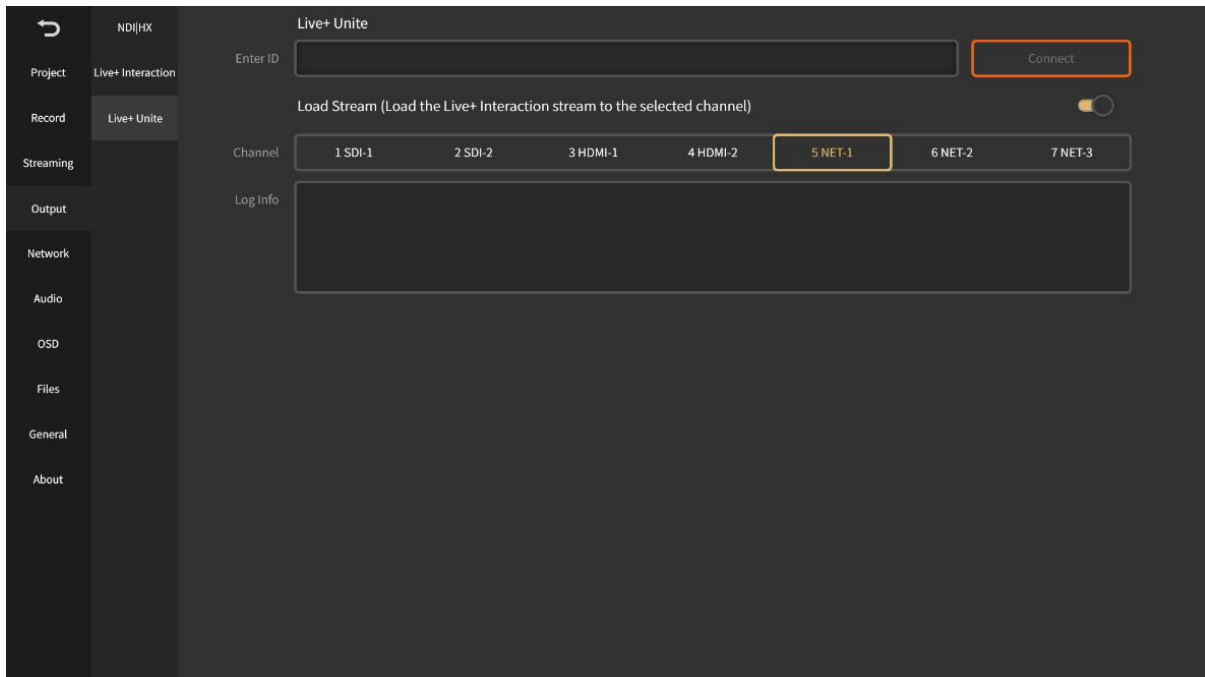

2.2.5 Network

NSCaster-X2 supports ethernet, WIFI and mobile networks. The status of the connection  is displayed on the main interface, green dot indicate that it is connected.

Ethernet: The default boot and the access network cable will automatically obtain the IP. Open DHCP and click "Apply" to get the IP address automatically, or turn off DHCP to manually modify the IP address as shown below:

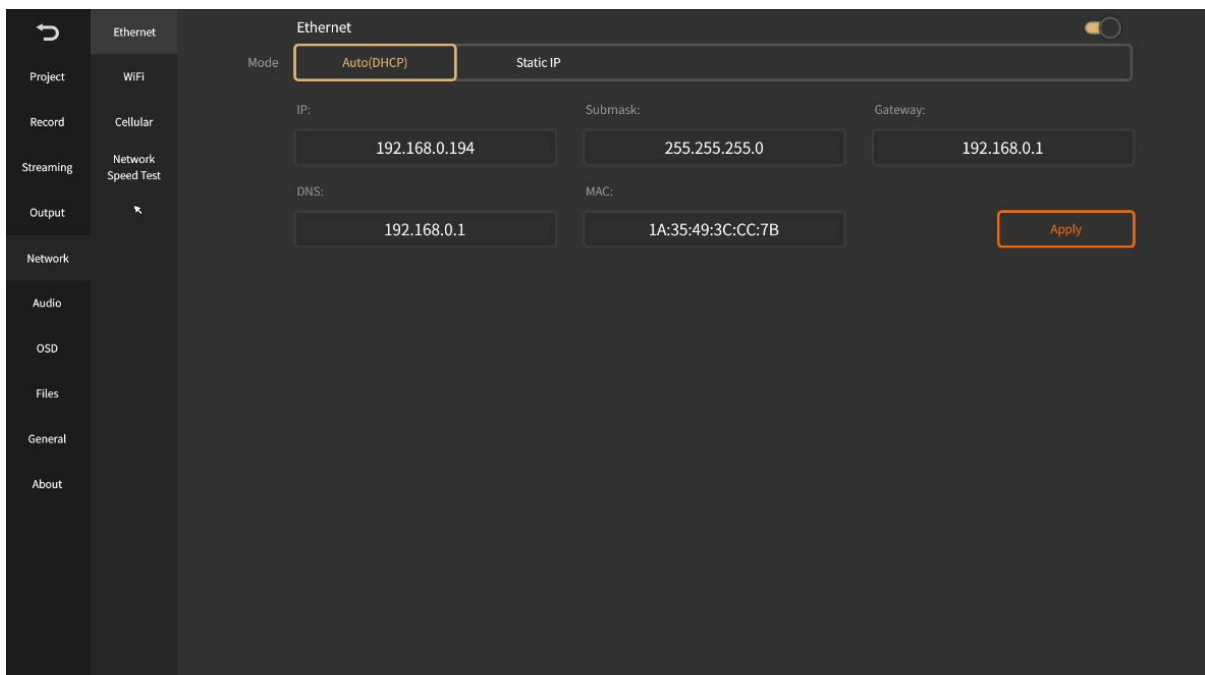

WiFi: Select the WiFi you want to connect and enter the correct password.

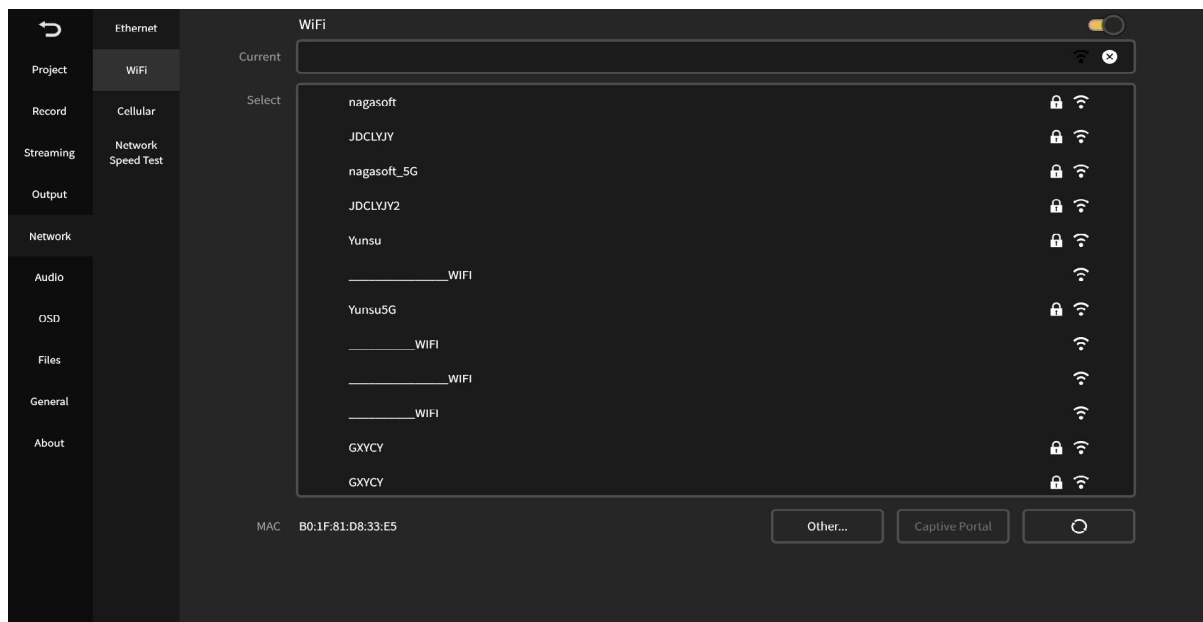

Mobile Network: When the mobile network is enabled, the SIM card will be automatically recognized when it is accessed, and 5G network applications are supported. When the SIM card opens the Pin Code, you must enter the PIN code to unlock the SIM card before you can identify the successful dialing. The Pin Code has only 3 chances to be entered.

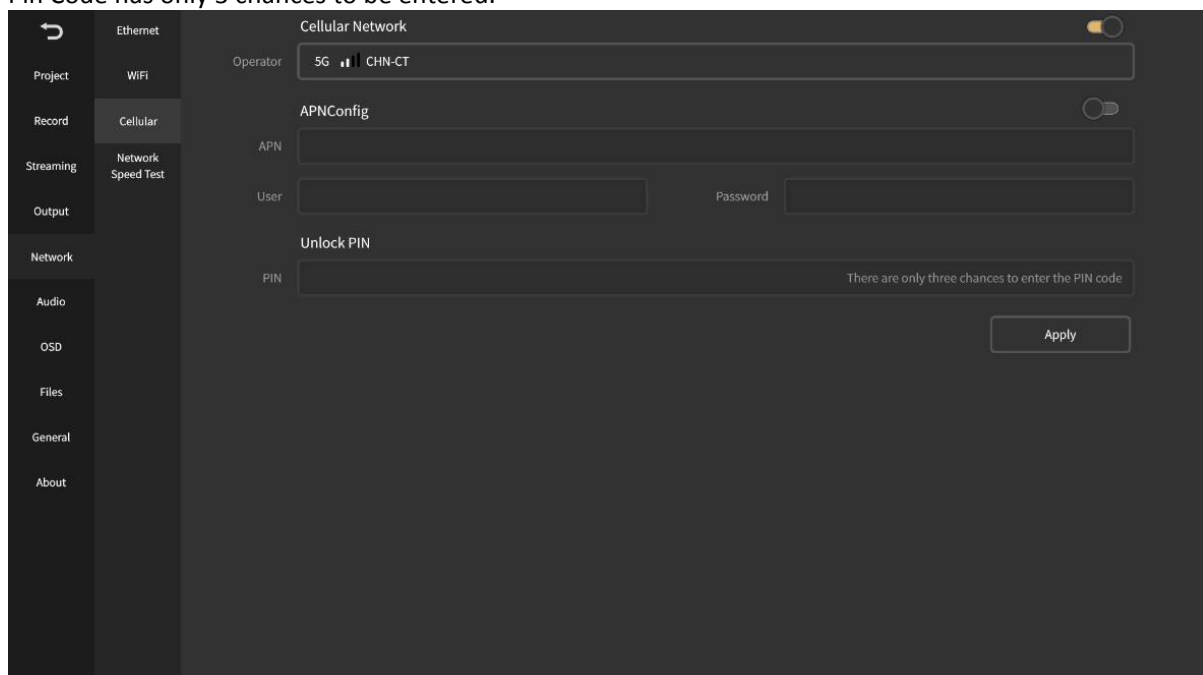

Network Speed Test: After connecting to the network, you can test the upload/download connection status of the network in real time, as shown in the following figure:

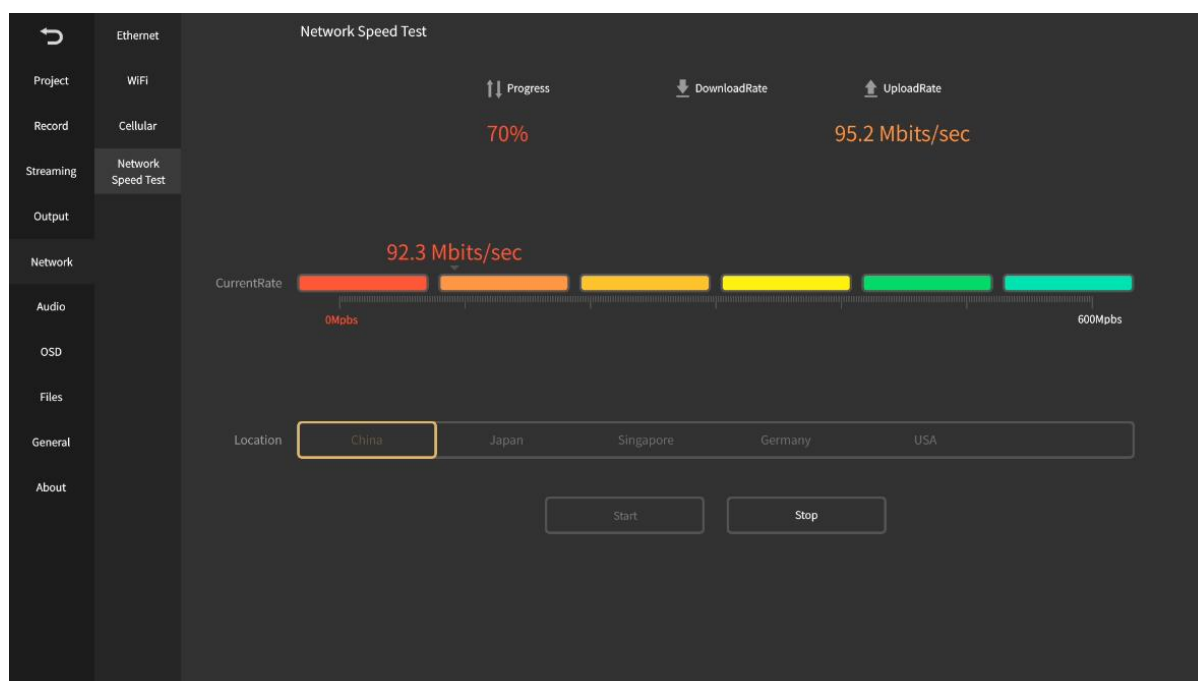

2.2.6 Audio Settings

The following settings can be made for audio input and output:

1. XLR input: Noise can be eliminated, and the noise threshold can be manually adjusted. The larger the noise threshold, the smaller the noise heard. Channel copy can be performed, and mono channels can be changed to left and right channels through channel copy.
2. Analog output: control the volume of analog output.
3. Audio delay: The delay of physical input sound can be controlled to ensure video and audio synchronization.
4. Tuning configuration: audio follow can be set.

The setting interface is shown in the figure below:

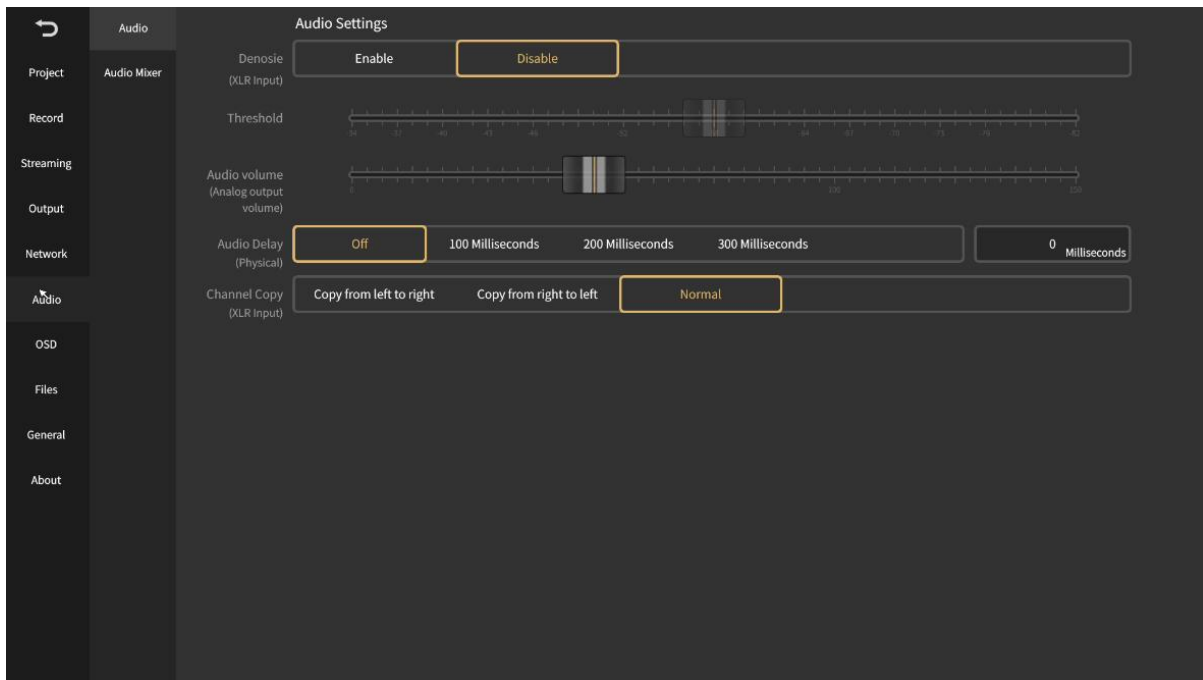

2.2.7 OSD Settings

It can support the display of the clock and remote CG overlay. The setting interface is shown below:

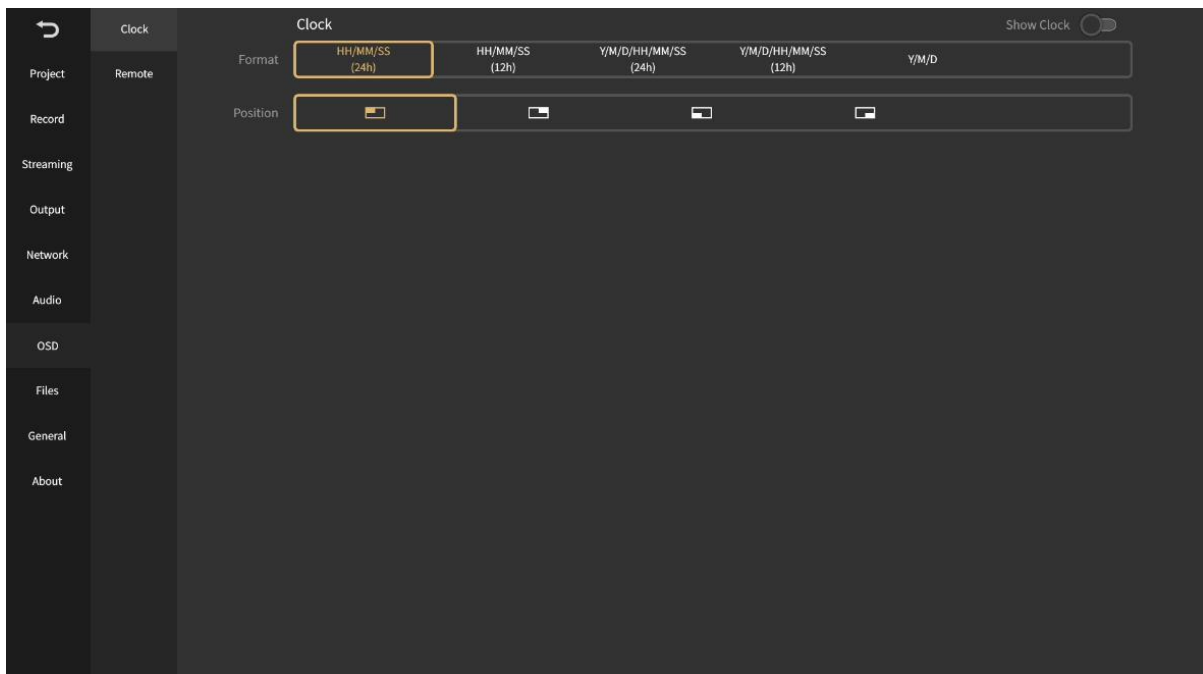

Clock Settings

Clock configuration status will let user know whether is on/off based on the status. If the status is “ON” means the clock is on right now and if the status is “OFF”, means that the clock is off. After being turned on, the current time can be displayed on the PGM monitor, and the format and the position of the clock support real-time switching as shown below:



Remote CG

Since this function needs to be used with the CG editor, the operation of the CG editor can be found in the appendix. Start the overlay function and set the remote CG port (default port 8017 / default password is admin), click Apply, as shown below:

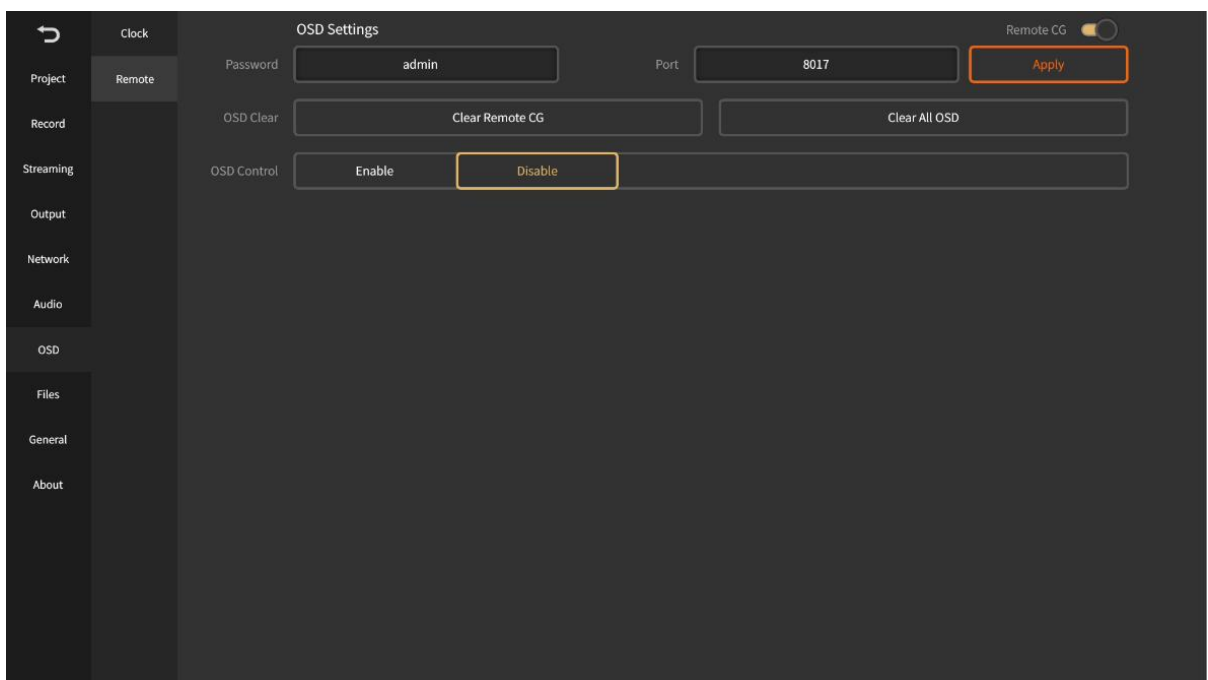

2.2.8 File Transfer



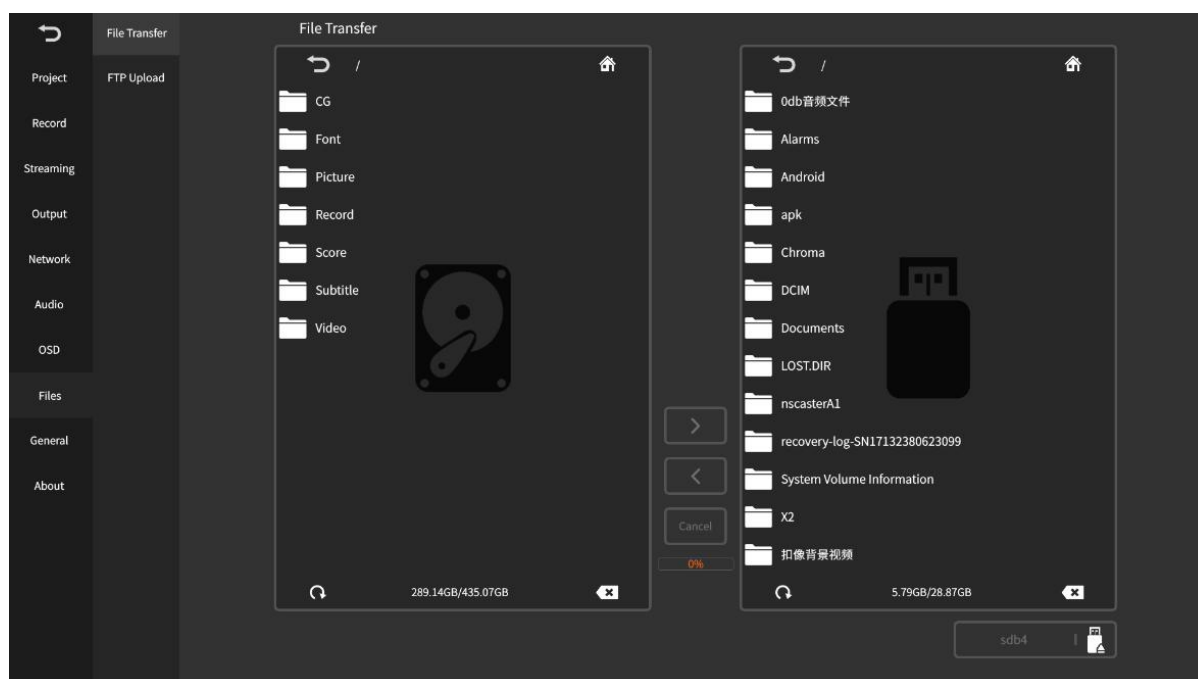





File transfer between local files and USB flash drives as shown below:



1) Local folder directory description:

- CG material: Store CG file
- Font: Store font styles
- Picture material: Store custom images, which can also be used for image overlay function and picture-in-picture custom template background.
- Recording: The "channel" folder stores channel recording files, "pgm" folder to store PGM recording files.
- Scoreboard template: Store customized scoreboard materials
- Subtitles: Store txt format subtitle file
- Video material: Store DDR playback video.

2) The button operation is as follows:

- Button  : Return to the main interface directory of the file
- Button  : Return to the previous directory
- Button  : Delete files
- Button  : Refresh
- Button  : Copy locally to a USB flash drive
- Button  : Copy from USB flash drive to local
- Button  : Remove USB flash
- Button  : During file copying, cancel the copy by the cancel button. Copy progress can refer to the percentage status of the progress bar.

2.2.9 General Settings

General settings includes the configuration of time zone and language, system, lock, assist and other modules. The interface is shown in the following figure::

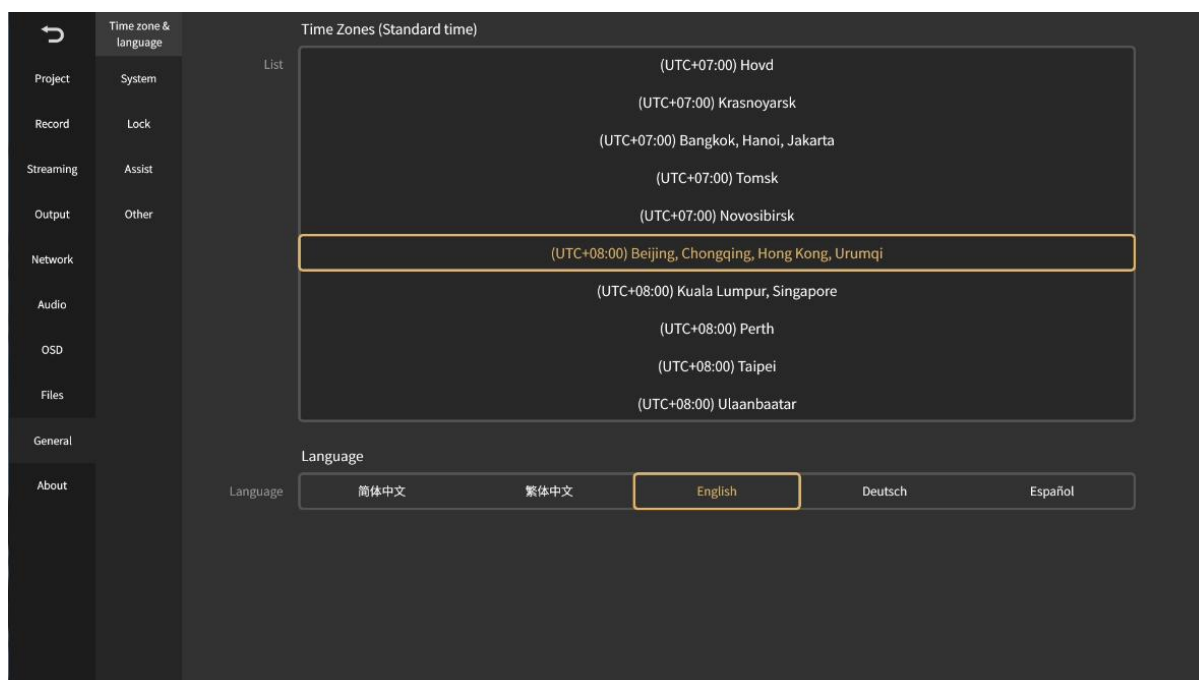

- 1) TimeZone: Support real-time switching between time zone and language
- 2) System: It can adjust the brightness of the screen display, the percentage of the cooling fan speed, restore the factory settings and restart the equipment, as shown in the following figure.

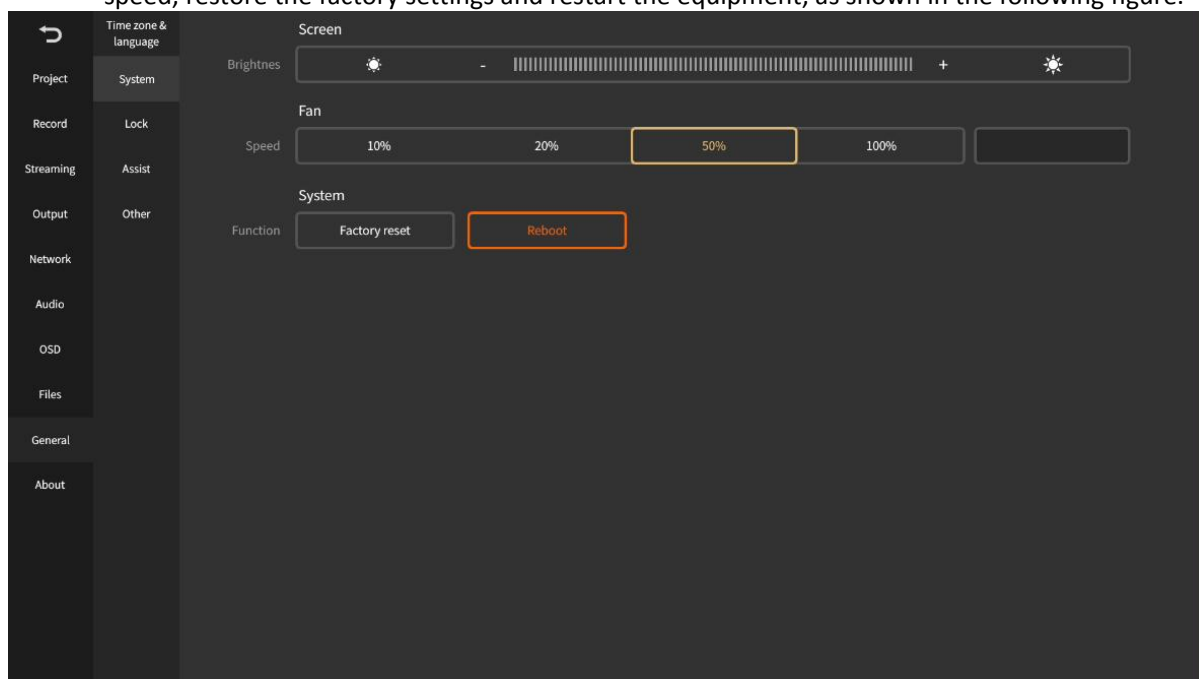

- 3) Lock: You can set the lock to prevent mistakes of start or stop streaming, recording and sound adjustment, and support the setting of the device password. After the device password is turned on, you need to enter the password to unlock after each startup and restart, as shown in the following figure:

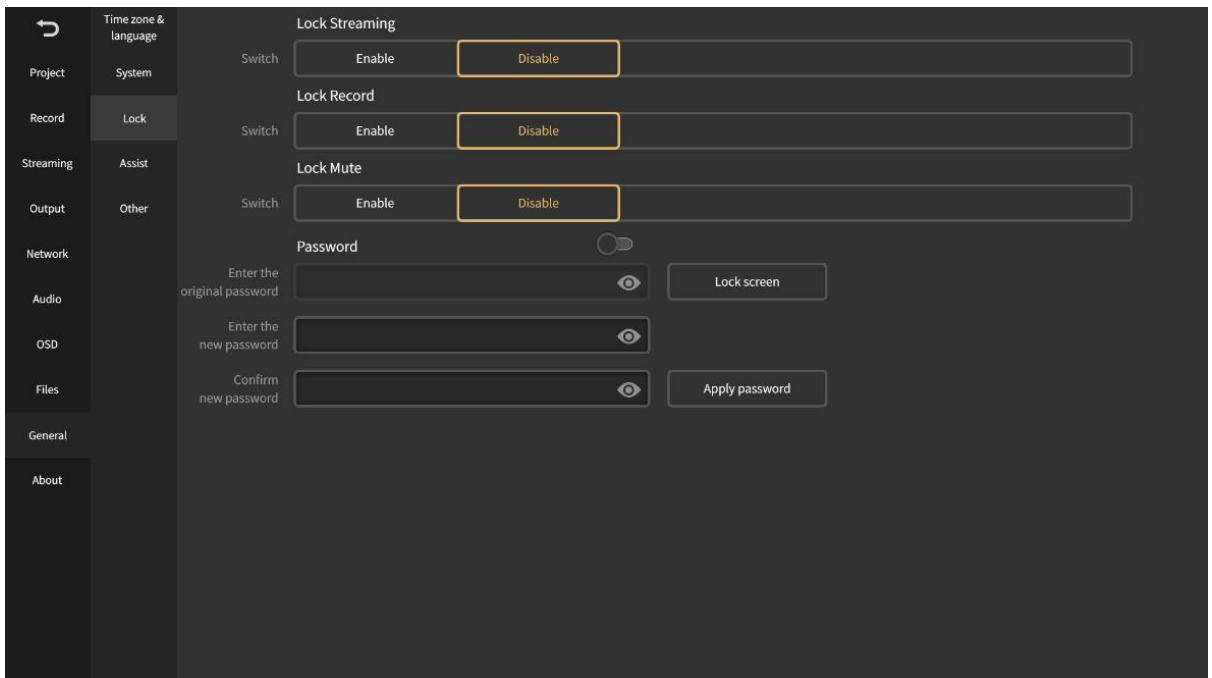

- 4) Assist: Mouse: enable/disable mouse to operate. Tally: enable/disable Tally output
- 5) Others: You can set the automatic streaming after boot, DDR channel cut in and cut out, network pull streaming and live+ connection buffer time, as shown in the following figure:

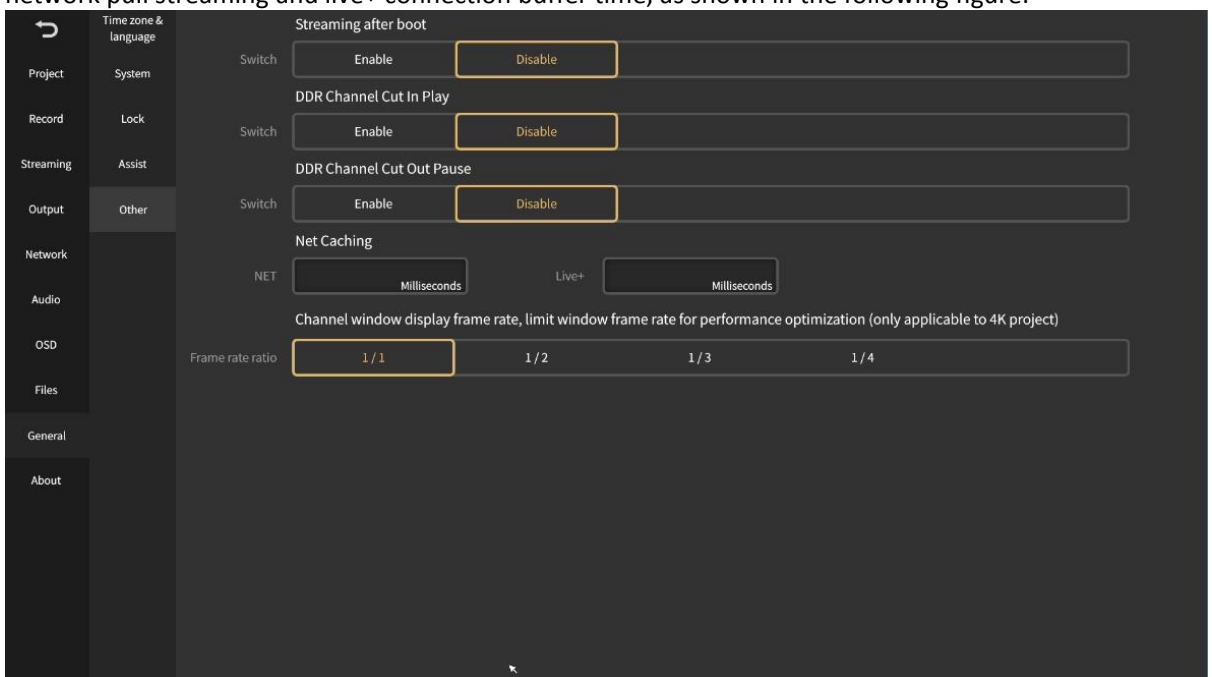

2.2.10 About

The device information interface displays the details of the current device. In that interface, user can also do the software update and firmware update when there is available. The interface looks like this:

