

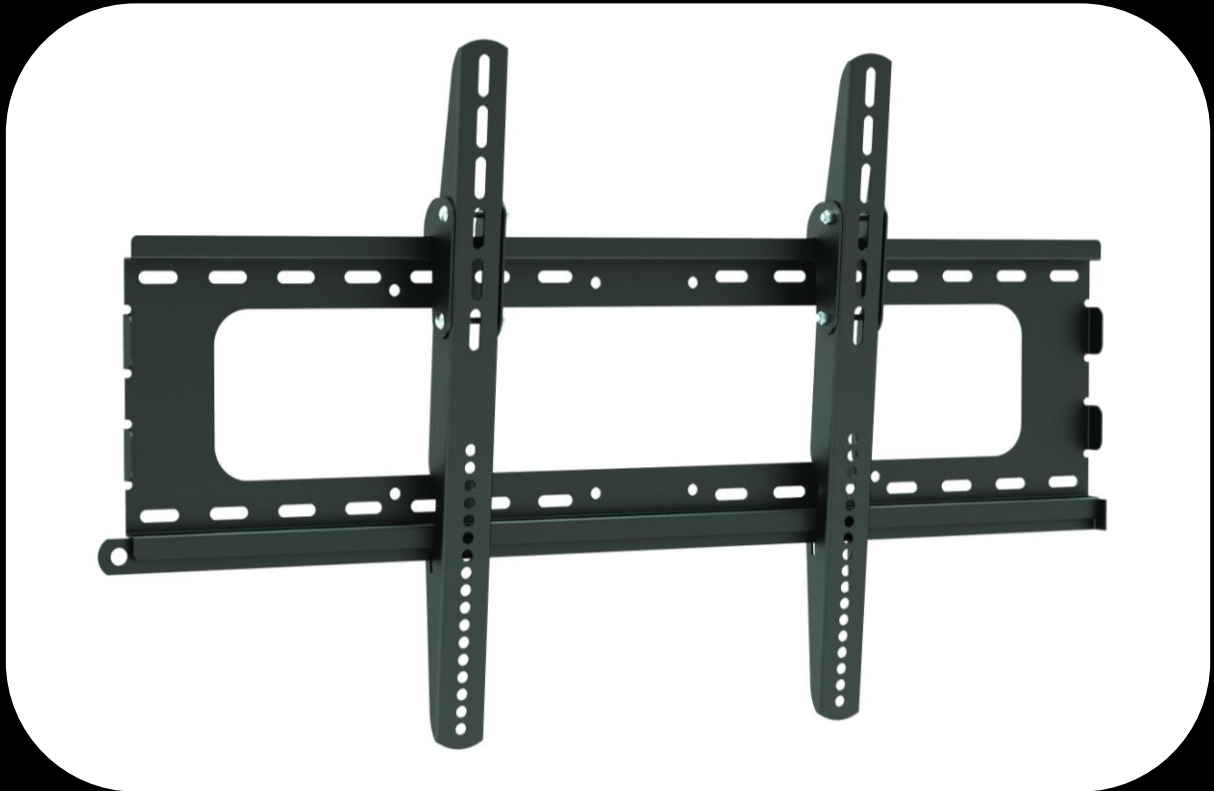

PLB-1N

ORDERCODE 100256



Highlite International B.V.
Vestastraat 2
6468 EX Kerkrade
The Netherlands
Phone: +31 45-5667700

SHOWELECTRONICS FOR PROFESSIONALS

Congratulations!

You have bought a great, innovative product from DMT.

The DMT PLB-1N brings excitement to any venue. Whether you want simple plug-&-play action or a sophisticated DMX show, this product provides the effect you need.

You can rely on DMT, for more excellent lighting products.

We design and manufacture professional light equipment for the entertainment industry.

New products are being launched regularly. We work hard to keep you, our customer, satisfied.

For more information: iwant@dutchmediatools.info

You can get some of the best quality, best priced products on the market from DMT.

So next time, turn to DMT for more great lighting equipment.

Always get the best -- with DMT !

Thank you!



DMT PLB-1N™ Product Guide

Warning 2

 Unpacking Instructions..... 2

 Tools required for installing the PLB-1N bracket 3

 Safety Instructions 3

 Operating Determinations 4

 Return Procedure..... 4

 Claims..... 4

Description of the device..... 5

 Overview 5

Installation..... 5

Set Up and Operation 5

 Wood stud wall Mounting 6

 Solid Brick and Concrete Block Mounting 7

 Installing Adapter Brackets 8

 Hang the brackets with the TV mounted onto the wall plate 9

 Mounting the TV screen with a pitching angle of 5° 9

 Locking TV rails..... 10

Maintenance 11

Product Specification 11

Warning

**FOR YOUR OWN SAFETY, PLEASE READ THIS USER MANUAL CAREFULLY
BEFORE YOUR INITIAL START-UP!**

Unpacking Instructions

Immediately upon receiving this product, carefully unpack the carton and check the contents to ensure that all parts are present, and have been received in good condition. Notify the dealer immediately and retain packing material for inspection if any parts appear damaged from shipping or the carton itself shows signs of mishandling. Save the carton and all packing materials. In the event that a bracket must be returned to the factory, it is important that the bracket be returned in the original factory box and packing.

Your shipment includes:

- DMT PLB-1N
- User manual

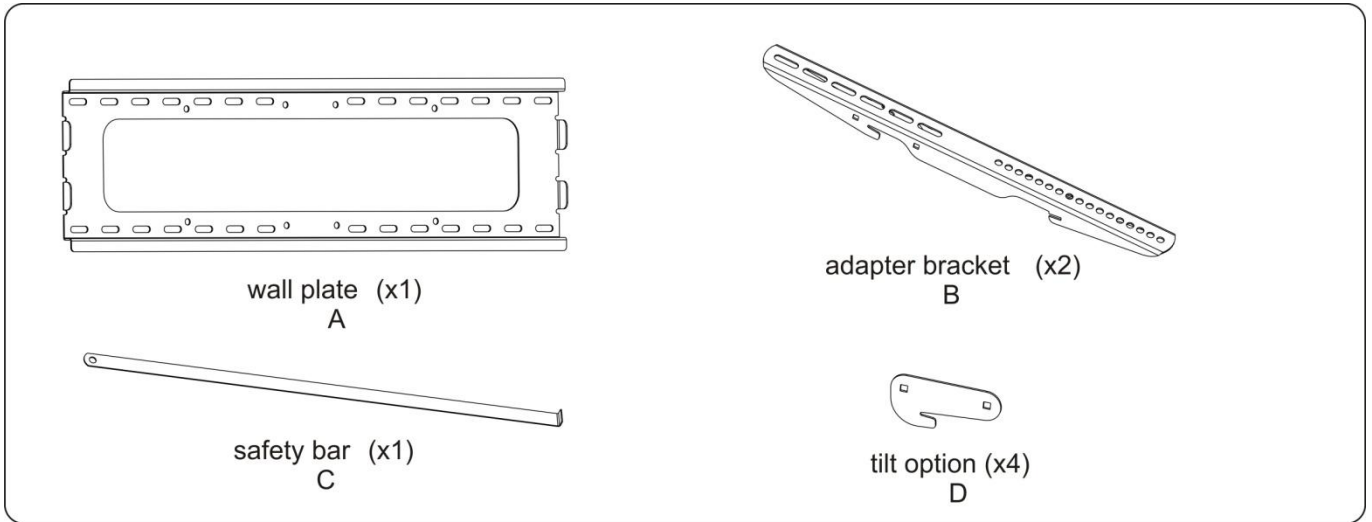

Package M

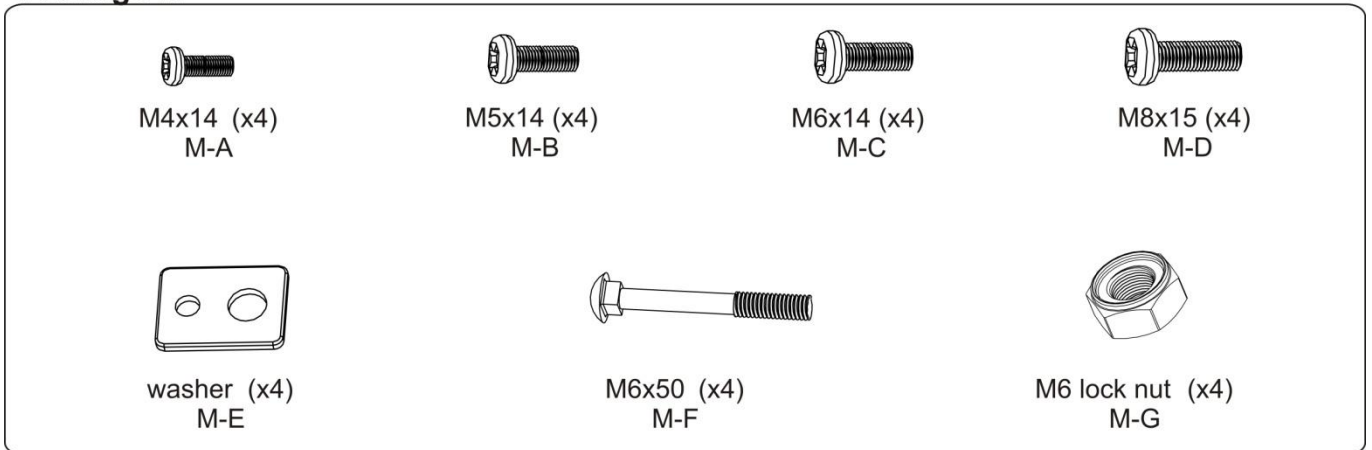

Package W

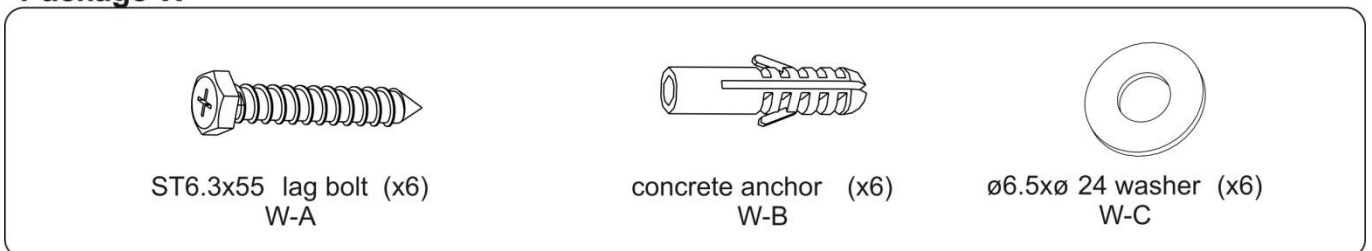

Tools required for installing the PLB-1N bracket

- Phillips Head Screw driver (200mm length excluding the handle)
- M6 Socket and Wrench
- Electric drill and 10 mm masonry bit for concrete wall installation
- Marking pen
- Hammer

Safety Instructions

Every person involved with the installation, operation and maintenance of this device has to:

- be qualified
- follow the instructions of this manual



Before your initial start-up, please make sure that there is no damage caused by transportation. Should there be any, consult your dealer and do not use the device.

To maintain perfect condition and to ensure a safe operation, it is absolutely necessary for the user to follow the safety instructions and warning notes written in this manual.

Please consider that damages caused by manual modifications to the device are not subject to warranty.

This device contains no user-serviceable parts. Refer servicing to qualified technicians only.

IMPORTANT:

The manufacturer will not accept liability for any resulting damages caused by the non-observance of this manual or any unauthorized modification to the device.

- Never exceed the maximum load capacity.
- Never remove warning or informative labels from the unit.
- Never lift the bracket including the Flatscreen TV by grabbing the bracket, as the bracket may become damaged. Always remove the Flatscreen TV first and then remove the bracket.
- Never leave any cables lying around.
- Do not begin the installation of this product before you have read the entire manual.
- Firmly tighten the screws, but do not overtighten. Overtightening can damage the bracket, thereby greatly reducing its holding power.
- When mounting the bracket to wood wall studs, make sure that the mounting screws are anchored into the center of the studs. Use of an "edge to edge" stud finder is highly recommended.
- Please read this manual carefully and keep it for future reference, especially for the required distance from bracket to the wall.
- Always use an assistant or mechanical lifting equipment to safely lift and position your equipment
- Do not shake the device. Avoid brute force when installing the bracket.
- Only use device indoor, avoid contact with water or other liquids.
- Avoid flames and do not put close to flammable liquids or gases.
- Make sure that the supporting surface will safely support the combined load of the equipment and all attached hardware and components.
- Make sure that the device is not exposed to extreme heat, moisture or dust.
- If the bracket is dropped or struck, have a qualified engineer inspect for safety before installing.
- For adult use only. Bracket must be installed by a qualified technician.
- Repairs, servicing and electric connection must be carried out by a qualified technician.
- WARRANTY: Till one year after date of purchase.

Operating Determinations

- If this product is operated in any other way, than the one described in this manual, the product may suffer damages and the warranty becomes void.
- Any other operation may lead to dangers like crash, etc.

You endanger your own safety and the safety of others!

Improper installation can cause serious damage to people and property !



Return Procedure

Returned merchandise must be sent prepaid and in the original packing, call tags will not be issued. Package must be clearly labeled with a Return Authorization Number (RMA number). Products returned without an RMA number will be refused. Highlite will not accept the returned goods or any responsibility. Call Highlite 0031-455667723 or mail aftersales@highlite.nl and request an RMA prior to shipping the fixture. Be prepared to provide the model number, serial number and a brief description of the cause for the return. Be sure to properly pack fixture, any shipping damage resulting from inadequate packaging is the customer's responsibility. Highlite reserves the right to use its own discretion to repair or replace product(s). As a suggestion, proper UPS packing or double-boxing is always a safe method to use.

Note: If you are given an RMA number, please include the following information on a piece of paper inside the box:

- 1) Your name
- 2) Your address
- 3) Your phone number
- 4) A brief description of the symptoms

Claims

The client has the obligation to check the delivered goods immediately upon delivery for any shortcomings and/or visible defects, or perform this check after our announcement that the goods are at their disposal. Damage incurred in shipping is the responsibility of the shipper; therefore the damage must be reported to the carrier upon receipt of merchandise.

It is the customer's responsibility to notify and submit claims with the shipper in the event that a fixture is damaged due to shipping. Transportation damage has to be reported to us within one day after receipt of the delivery.

Any return shipment has to be made post-paid at all times. Return shipments must be accompanied with a letter defining the reason for return shipment. Non-prepaid return shipments will be refused, unless otherwise agreed in writing.

Complaints against us must be made known in writing or by fax within 10 working days after receipt of the invoice. After this period complaints will not be handled anymore.

Complaints will only then be considered if the client has so far complied with all parts of the agreement, regardless of the agreement of which the obligation is resulting.

Description of the device

Features

The DMT PLB-1N is a bracket for Flatscreen TV's.

- Fixed Wall Mount
- Maximum Load: 75 kg (165lbs)
- Screensize: 32" - 60"
- Tilt adjustment (Pitching Angle): 0° or 5°
- Max VESA: 600 x 400 mm compliant
- Mounting Pattern: 765 x 480 mm (LxWxH)
- Weight: 3,4 kg

Overview

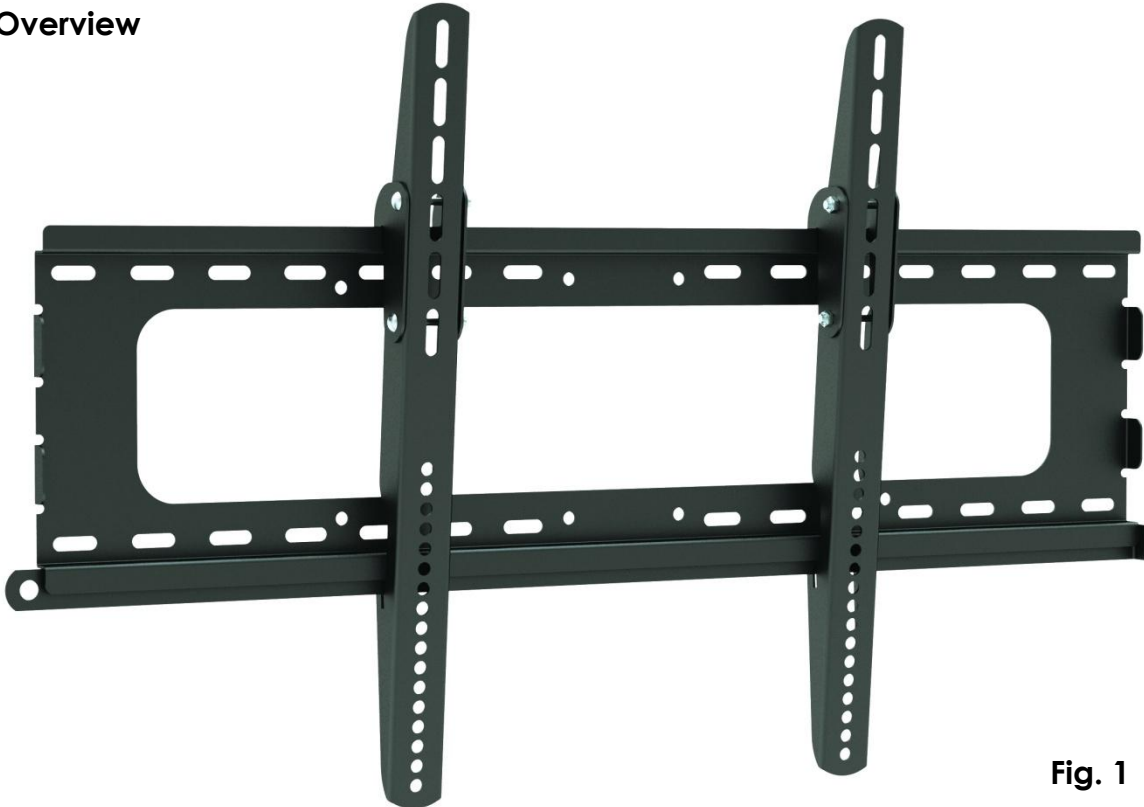

Fig. 1

Installation

Remove all packing materials from the PLB-1N. Check that all foam and plastic padding is removed.

Always disconnect all components from electric mains power supply before cleaning or servicing.
Damages caused by non-observance are not subject to warranty.

If you have any doubts regarding the installation, please consult your retailer or service department for more details.

Set Up and Operation

Follow the directions below, as they pertain to your preferred operation mode.

Before plugging in all components, always make sure that the power supply matches the product specification voltage.

Wood stud wall Mounting

Warning

- Make sure that the supporting surface will safely support the combined load of the equipment and all attached hardware and components.
- Firmly tighten the woodscrews, but do not overtighten. Overtightening can damage the bracket, thereby greatly reducing their holding power.
- When mounting the bracket to wood wall studs, make sure that the mounting screws are anchored into the center of the studs. Use of an “edge to edge” stud finder is highly recommended.
- Hardware provided is for mounting through or attachment to a standard thickness drywall or plaster into studs. Installers are responsible to provide hardware for other types of mounting situations.

- 1) The wall plate must be mounted to the two studs. Use a stud finder to locate the edges of the studs. It is highly recommended to use an edge-to-edge stud finder. Based on the edges, draw a vertical line down each stud's center.
- 2) Gently place the wall plate on the wall as a template. Mark the center of the four mounting holes. Make sure that the mounting holes are on the stud centerline.
- 3) Drill four 1/8" (3mm) dia. holes 1.2" (30mm) deep. Secure it by using four lag bolts (W-A) and four M6 washers (W-C) as shown in Fig. 2.

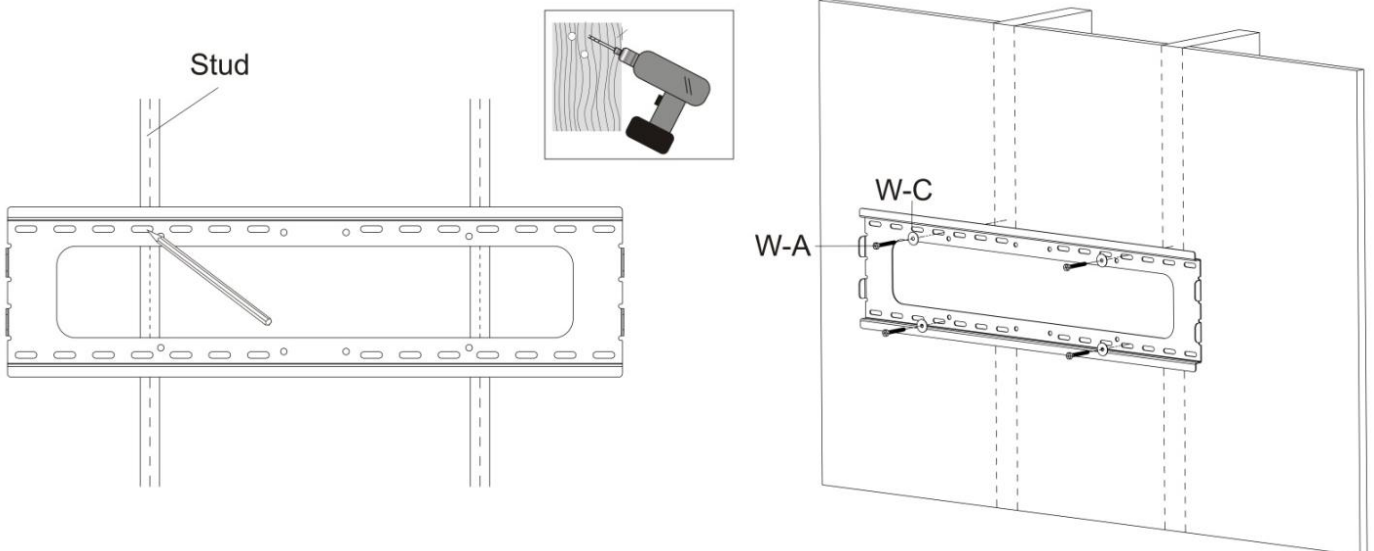

Fig. 2

Solid Brick and Concrete Block Mounting

Warning

- When installing the wall mounts on a cinderblock, verify that you have a minimum of 1-3/8" of actual concrete thickness in the hole to be used for the concrete anchors.
- Do not drill into mortar joints!
- Be sure to mount on a solid part of the block, with a 1" minimum from the side of the block. You should use an electric drill at low speed to drill the hole, instead of a hammer drill to avoid breaking out the back of the hole when entering a void or cavity.
- The installer must verify that the supporting surface will safely support the combined load of the equipment and all attached hardware and components.
- Use the wall plate as a template to mark the 6 holes on the wall. Four in the top row slots and two more in the bottom row, as shown in Fig. 3.

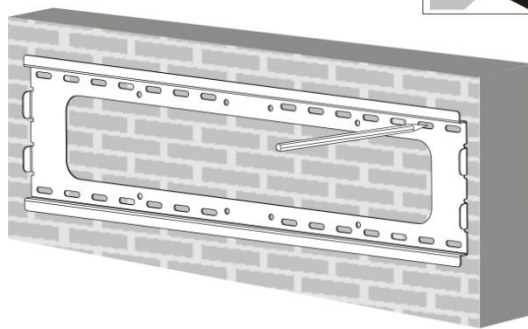
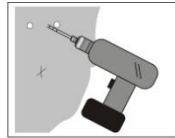

Fig. 3

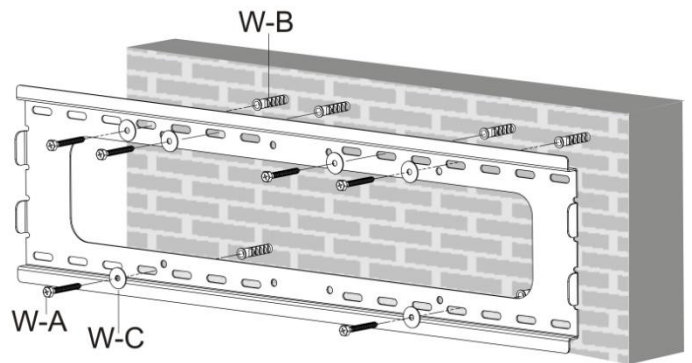

Fig. 4

- Pre-drill these holes with a 10mm masonry bit to a depth of at least 60mm. Insert a concrete anchor (W-B) into each of these holes. Attach the wall plate to the wall by using 6x lag bolts (W-A) and 6x M6 washers (W-C), as shown in Fig. 4.

Installing Adapter Brackets

- To prevent scratching of the TV screen, take a soft cloth and place it on a flat, leveled surface which will support the weight of the screen. Be sure that there are no objects (screws, etc) laying below the cloth.
- Place the TV screen face side down. Place the adapter brackets on the back of the screen, align the holes and center them on the back of the screen, as shown in Fig. 5.

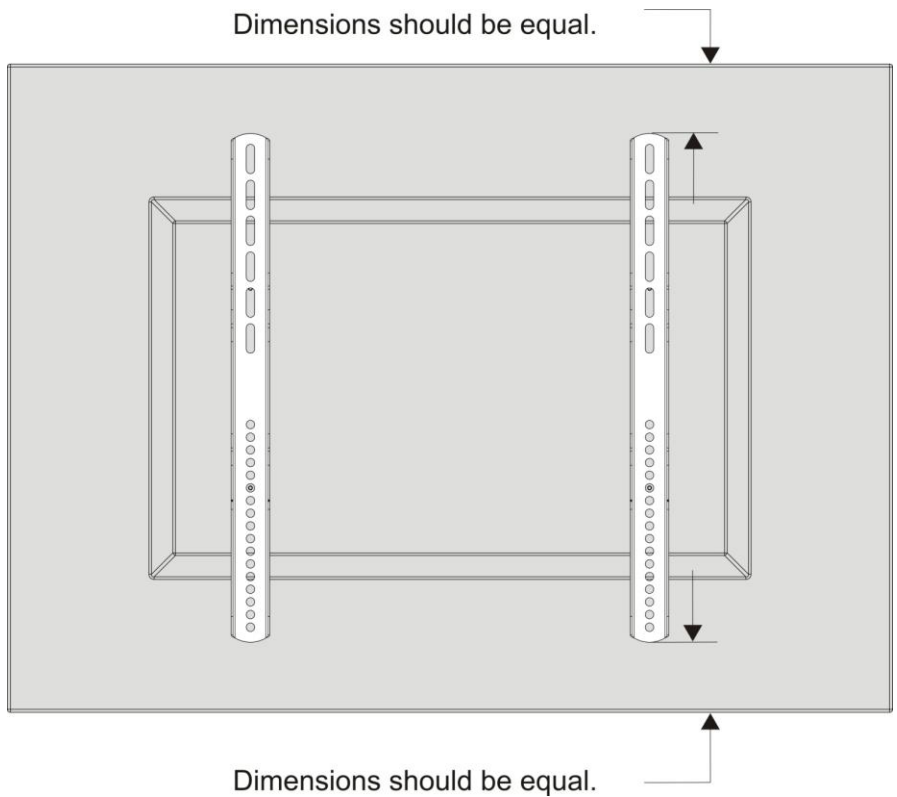

Fig. 5

- Attach the adapter brackets to the back of the screen by using the appropriate combination of screws, washers, as shown in Fig. 6.

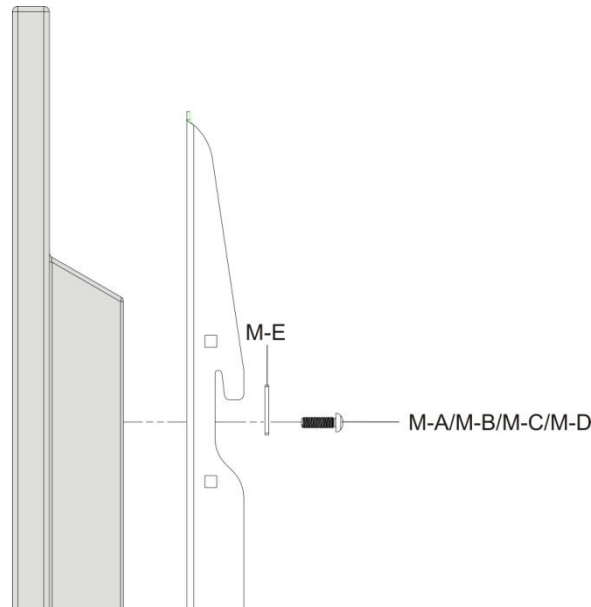

Fig. 6

- Begin with the shortest screw, hand thread it through the washer and the adapter bracket and into the screen as shown in Fig. 6.
- The screws must be turned at least three full turns into the mounting hole. It should be carefully fitted into place. Be sure to fasten the screws snugly. Do not over tighten.
- If a screw cannot be turned three full turns into the screens mounting hole, select a longer screw from the baffled fastener pack. Repeat this process for the remaining mounting holes, level the brackets and tighten the screws snugly. Do not over tighten.

Hang the brackets with the TV mounted onto the wall plate

Warning: At least 2 qualified people are required to execute this operation.

Mounting the TV screen with a pitching angle of 0° (vertical)

- After the wall mounting bracket has been safely secured to the wall, carefully lift your TV (with 2 people) and hook the top hooks over the top of the wall plate rail, as shown in Fig. 7.

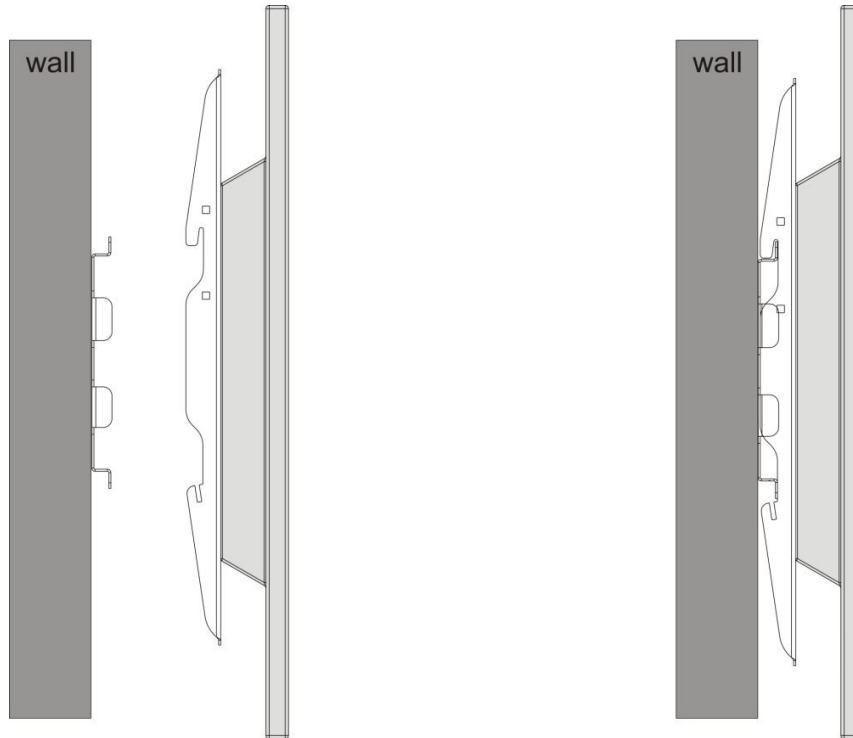

Fig. 7

Mounting the TV screen with a pitching angle of 5°

Warning: At least 2 qualified people are required to execute this operation

- Attach the tilt option (D) to the TV rails by using the M6 screws (M-F) and the M6 lock nuts (M-G) as shown in Fig. 8.
- After the wall mounting bracket has been safely secured to the wall, carefully lift your TV (with 2 people) and hook the top hooks over the top of the wall plate rail, as shown in Fig. 8.

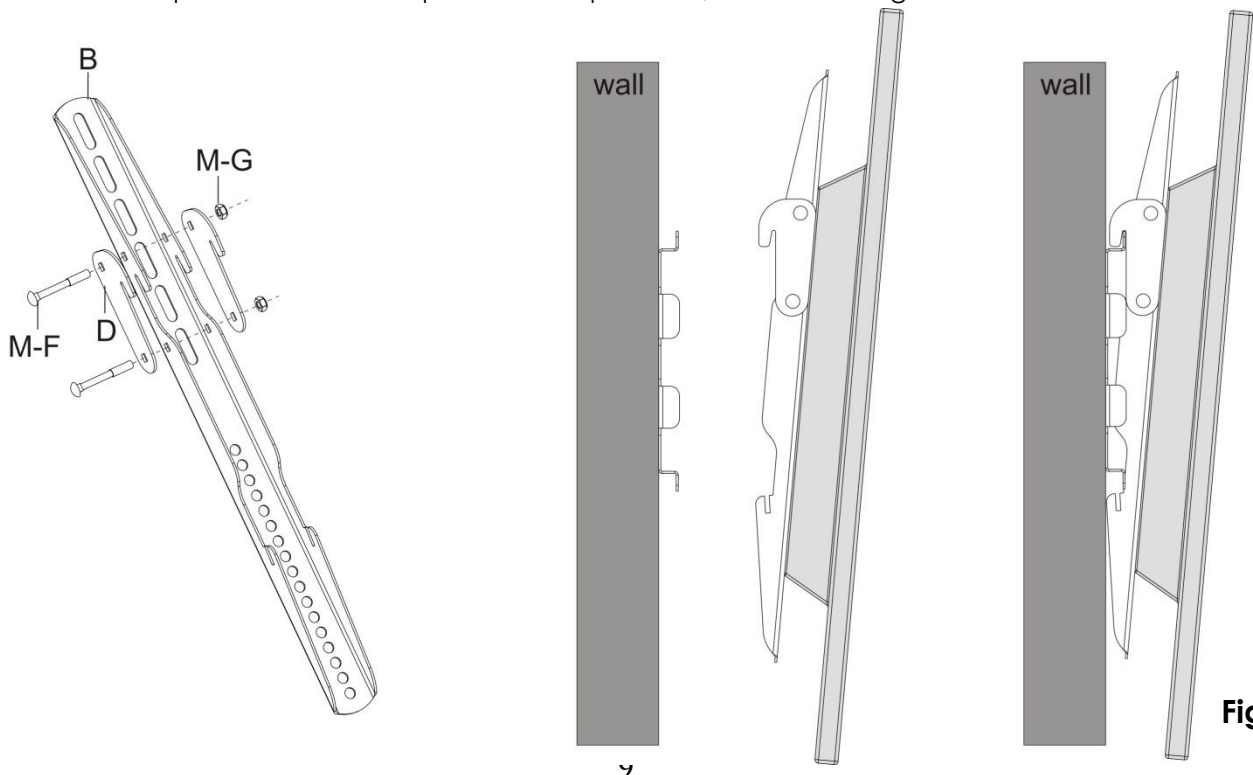

Fig. 8

Locking TV rails

- Insert the safety bar (C) to secure the rails. Use a padlock to lock the TV screen into place. For a better overview and more clarity, the TV screen is not shown in Fig. 9 and Fig. 10.

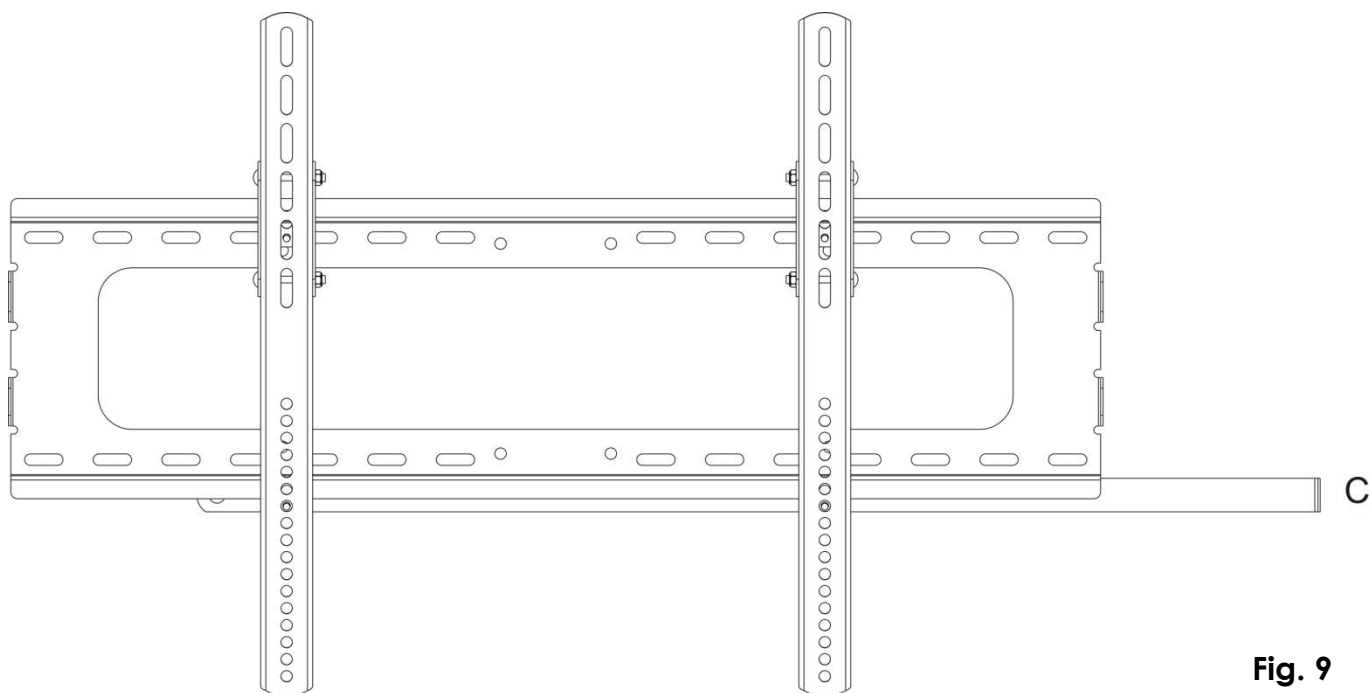

Fig. 9

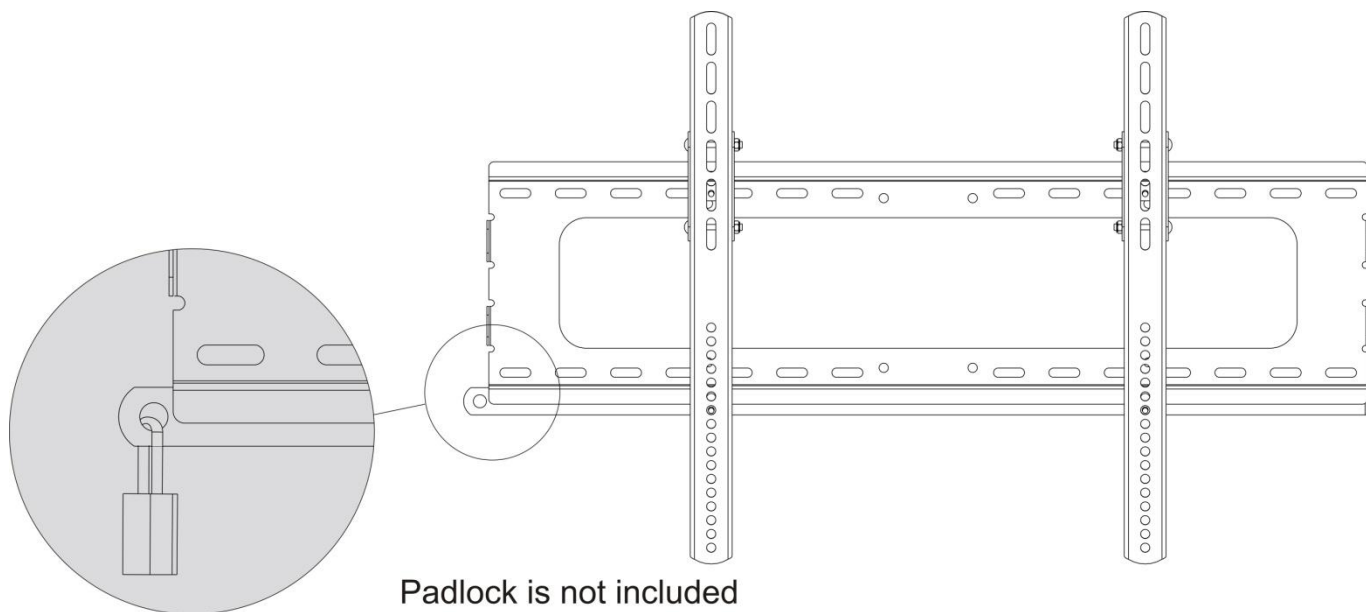

Fig. 10

Important: Make sure the TV screen is correctly hooked and the safety locking bars are locked safely.

Maintenance

The operator has to make sure that safety-relating and machine-technical installations are to be inspected by an expert after every year in the course of an acceptance test.

The operator has to make sure that safety-relating and machine-technical installations are to be inspected by a skilled person once a year.

The following points have to be considered during the inspection:

1. All screws used for installing the device or parts of the device have to be tightly connected and must not be corroded.
2. There may not be any deformations on housings, fixations and installation spots.
3. Mechanically moving parts like axles, eyes and others may not show any traces of wearing.
4. The electric power supply cables must not show any damages or material fatigue.

The DMT PLB-1N requires almost no maintenance. However, you should keep the unit clean, by wiping the cover with a damp cloth. Do not immerse in liquid. Do not use alcohol or solvents.

Product Specification

Model: DMT PLB-1N

Fixed Wall Mount

Maximum Load: 75 kg (165lbs)

Screen size: 32" - 60"

Tilt adjustment (Pitching Angle): 0° or 5°

Max VESA: 600 x 400 mm compliant

Mounting Pattern: 765 x 480 mm (LxWxH)

Weight: 3,4 kg

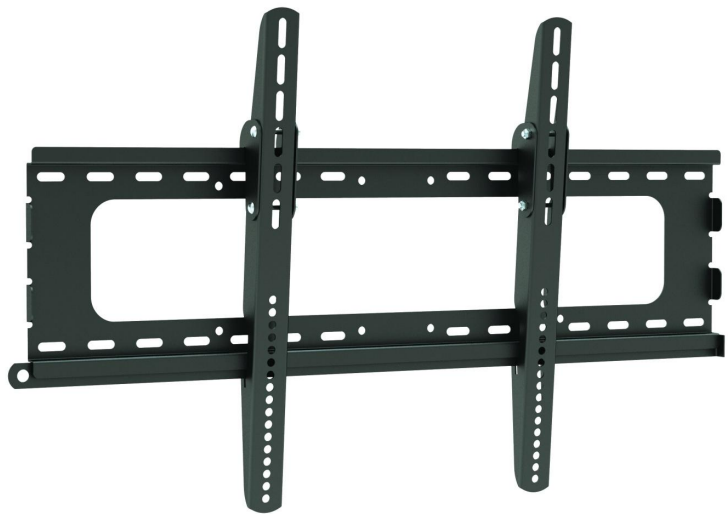

Design and product specifications are subject to change without prior notice.



Website: www.DutchMediaTools.info

Email: service@highlite.nl



DUTCH MEDIA TOOLS

© 2012 DMT.