

ENGLISH

D1 Videomixer with scaler V1

Ordercode: 101281

Table of contents

Warning	3
Safety Instructions	3
Operating Determinations	4
Connection with the mains	5
Return Procedure	5
Claims	5
Description of the device	6
Front	7
Back	8
Installation	9
Setup and Operation	9
Control Panel	9
Menu Overview	10
Main Menu Options	13
1. Input	15
2. Output	15
2.1. Output Format	16
2.2. Output Setting	16
2.2.1. ColorSpace/Sample/Bit	16
2.3. External Sync	16
2.4. Test Pattern	16
3. Freeze	17
4. Black	18
5. Scale	18
6. Transition	19
7. DSK	20
8. Blend	20
9. Logo	21
10. Mask	21
11. Audio Input	22
12. Audio Output	22
13. Front Panel Lock	23
14. Settings	23
14.1. Transition	23
14.2. Version	23
14.3. Ethernet	24
14.3.1. IP	24
14.3.2. Subnet Mask	24
14.3.3. Gateway	25
14.3.4. State	25
14.4. T-Bar Correction	25
14.5. Fader Correction	25
14.6. Key Board	26
14.6.1. Custom	26
14.6.2. Key Board Test	26
14.7. Advance	26
15. Factory Reset	27
Operations	27
Start-up	27
Layering/PIP/MASK/SCALE	27
Saving Presets	28
Loading Presets	28
Creating a Custom Logo	29

PST/PGM Logo	31
Maintenance	31
Troubleshooting	31
No Output	31
Screen Only Displays a Part of the Image	31
Output Does Not Fill the Entire Screen	32
Black Spots Appear on the Sides of the Screen	32
Product Specifications	32
Dimensions	33

Warning



**For your own safety, please read this user manual carefully
before your initial start-up!**



Unpacking Instructions

Immediately upon receiving this product, carefully unpack the carton and check the contents to ensure that all parts are present, and have been received in good condition. Notify the dealer immediately and retain packing material for inspection if any parts appear damaged from shipping or the carton itself shows signs of mishandling. Save the carton and all packing materials. In the event that a fixture must be returned to the factory, it is important that the fixture be returned in the original factory box and packing.

Your shipment includes:

- D1 Videomixer
- 2 x HDMI-HDMI cable (1,3 m)
- 1 x USB cable (1,3 m)
- 1 x CAT5 cable (1,3 m)
- Schuko to IEC power cable (1,3 m)
- User manual

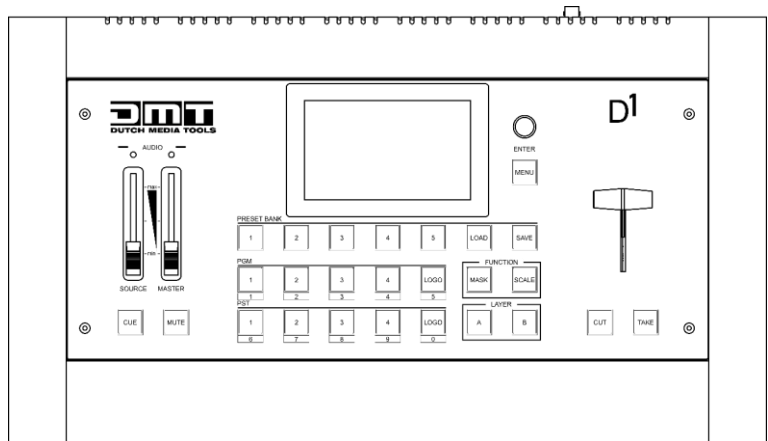

CAUTION!

**Keep this device away from rain and moisture!
Unplug mains lead before opening the housing!**



Safety Instructions

Every person involved with the installation, operation and maintenance of this system has to:

- be qualified
- follow the instructions of this manual



**CAUTION! Be careful with your operations.
With a dangerous voltage you can suffer
a dangerous electric shock when touching the wires!**



Before the initial start-up, please make sure that there is no damage caused by transportation. Should there be any, consult your dealer and do not use the system.

To maintain perfect condition and to ensure a safe operation, it is absolutely necessary for the user to follow the safety instructions and warning notes written in this manual.

Please consider that damages caused by manual modifications to the system are not subject to warranty. This system contains no user-serviceable parts. Refer servicing to qualified technicians only.

IMPORTANT:

The manufacturer will not accept liability for any resulting damages caused by the non-observance of this manual or any unauthorized modification to the system.

- Never let the power cord come into contact with other cables! Handle the power cord and all connections with the mains with particular caution!
- Never remove warning or informative labels from the unit.
- Never use anything to cover the ground contact.
- Never leave any cables lying around.
- Do not insert objects into air vents.
- Do not connect this device to a dimmer pack.
- Do not switch the device on and off in short intervals, as this would reduce the device's life.
- Do not shake the device. Avoid brute force when installing or operating the device.
- Only use device indoors, avoid contact with water or other liquids.
- Only operate the fixture after having checked that the housing is firmly closed and all screws are tightly fastened.
- Only operate the device after having familiarized with its functions.
- Avoid flames and do not put close to flammable liquids or gases.
- Always keep case closed while operating.
- Always allow free air space of at least 50 cm around the unit for ventilation.
- Always disconnect power from the mains, when device is not used or before cleaning! Only handle the power cord by the plug. Never pull out the plug by tugging the power cord.
- Make sure that the device is not exposed to extreme heat, moisture or dust.
- Make sure that the available voltage is not higher than stated on the rear panel.
- Make sure that the power cord is never crimped or damaged. Check the device and the power cord from time to time.
- If device is dropped or struck, disconnect mains power supply immediately. Have a qualified engineer inspect for safety before operating.
- If the device has been exposed to drastic temperature fluctuation (e.g. after transportation), do not switch it on immediately. The arising condensation water might damage your device. Leave the device switched off until it has reached room temperature.
- If your DMT device fails to work properly, discontinue use immediately. Pack the unit securely (preferably in the original packing material), and return it to your DMT dealer for service.
- For adult use only. Device must be installed out of the reach of children. Never leave the unit running unattended.
- Never attempt to bypass the thermostatic switch or fuses.
- The user is responsible for correct positioning and operating of the D1 Videomixer. The manufacturer will not accept liability for damages caused by the misuse or incorrect installation of this device.
- This device falls under protection class I. Therefore it is essential to connect the yellow/green conductor to earth.
- Repairs, servicing and electric connection must be carried out by a qualified technician.
- **WARRANTY:** Till one year after date of purchase.

Operating Determinations

- This device is not designed for permanent operation. Consistent operation breaks will ensure that the device will serve you for a long time without defects.
- The maximum ambient temperature $t_a = 40\text{ °C}$ must never be exceeded.
- The relative humidity must not exceed 50 % with an ambient temperature of 40 °C .
- If this device is operated in any other way, than the one described in this manual, the product may suffer damages and the warranty becomes void.
- Any other operation may lead to dangers like short-circuit, burns, electric shock, crash etc.

You endanger your own safety and the safety of others!

Improper installation can cause serious damage to people and property!

Connection with the mains

Connect the device to the mains with the power-plug.

Always pay attention, that the right color cable is connected to the right place.

International	EU Cable	UK Cable	US Cable	Pin
L	BROWN	RED	YELLOW/COPPER	FASE
N	BLUE	BLACK	SILVER	NULL
	YELLOW/GREEN	GREEN	GREEN	EARTH

Make sure that the device is always connected properly to the earth!

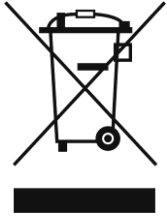

Return Procedure

Returned merchandise must be sent prepaid and in the original packing, call tags will not be issued. Package must be clearly labeled with a Return Authorization Number (RMA number). Products returned without an RMA number will be refused. Highlite will not accept the returned goods or any responsibility. Call Highlite 0031-455667723 or mail aftersales@highlite.com and request an RMA prior to shipping the fixture. Be prepared to provide the model number, serial number and a brief description of the cause for the return. Be sure to properly pack fixture, any shipping damage resulting from inadequate packaging is the customer's responsibility. Highlite reserves the right to use its own discretion to repair or replace product(s). As a suggestion, proper UPS packing or double-boxing is always a safe method to use.

Note: If you are given an RMA number, please include the following information on a piece of paper inside the box:

- 01) Your name
- 02) Your address
- 03) Your phone number
- 04) A brief description of the symptoms

Claims

The client has the obligation to check the delivered goods immediately upon delivery for any shortcomings and/or visible defects, or perform this check after our announcement that the goods are at their disposal. Damage incurred in shipping is the responsibility of the shipper; therefore the damage must be reported to the carrier upon receipt of merchandise.

It is the customer's responsibility to notify and submit claims with the shipper in the event that a fixture is damaged due to shipping. Transportation damage has to be reported to us within one day after receipt of the delivery.

Any return shipment has to be made post-paid at all times. Return shipments must be accompanied with a letter defining the reason for return shipment. Non-prepaid return shipments will be refused, unless otherwise agreed in writing.

Complaints against us must be made known in writing or by fax within 10 working days after receipt of the invoice. After this period complaints will not be handled anymore.

Complaints will only then be considered if the client has so far complied with all parts of the agreement, regardless of the agreement of which the obligation is resulting.

Description of the device

The D1 Videomixer makes video scaling and mixing more accessible and intuitive than ever before. It is equipped with the latest technologies and innovations, which makes it a fully integrated all-in-one video processor.

The integrated touch screen and the large illuminated buttons make accessing the different functions an easy task. The built-in audio features enable outputting from embedded audio or external sources. The D1 includes both cross-conversion and pixel-to-pixel scaling for modern displays, making this a comprehensive video solution for meeting rooms, schools, houses of worship and rental video productions.

Features

- Input voltage: 100–240 V AC, 50/60 Hz
- Power consumption: 65 W
- Inputs: 4 x HDMI
- Output program (PGM): 1 x HDMI
- Output preview (PVW): 1 x HDMI
- Input resolutions HDMI: SMPTE: 625@25/50 PAL | 525@29,97/59,94 NTSC | 1080p@50/59,94/60 | 1080i@50/59,94/60 | 720p@50/59,94/60
VESA: 800x600@60 | 1024x768@60 | 1280x768@60 | 1280x1024@60 | 1600x1200@60 | 1920x1080@60
- Output resolutions: SMPTE: 480i | 576i | 625@25/50 PAL | 525@29,97/59,94 NTSC | 1080p@50/59,94/60 | 1080i@50/59,94/60 | 720p@50/59,94/60
VESA: 800x600@60 | 1024x768@60 | 1280x768@60 | 1280x1024@60 | 1600x1200@60 | 1920x1080@60
- Genlock Y In: Black Burst: 480i | 576i | 720p@50/59,94 | 1080i@50/59,94 | 1080p@50/59,94/60 | 1080psf@23,98/24
- Grayscale processing: 12 bit
- Processing engine: 10 bit
- Layers: 2
- DSK/Chroma-key: Yes (foreground layer)
- Blend: Yes (foreground layer)
- Mask: Yes (foreground layer)
- Transition effect: Yes
- Humidity: 10–90 %
- Operating temperature: -25 °C to +55 °C
- Dimensions: 483 x 290 x 105 mm (LxWxH)
- Weight: 5,7 kg

Front

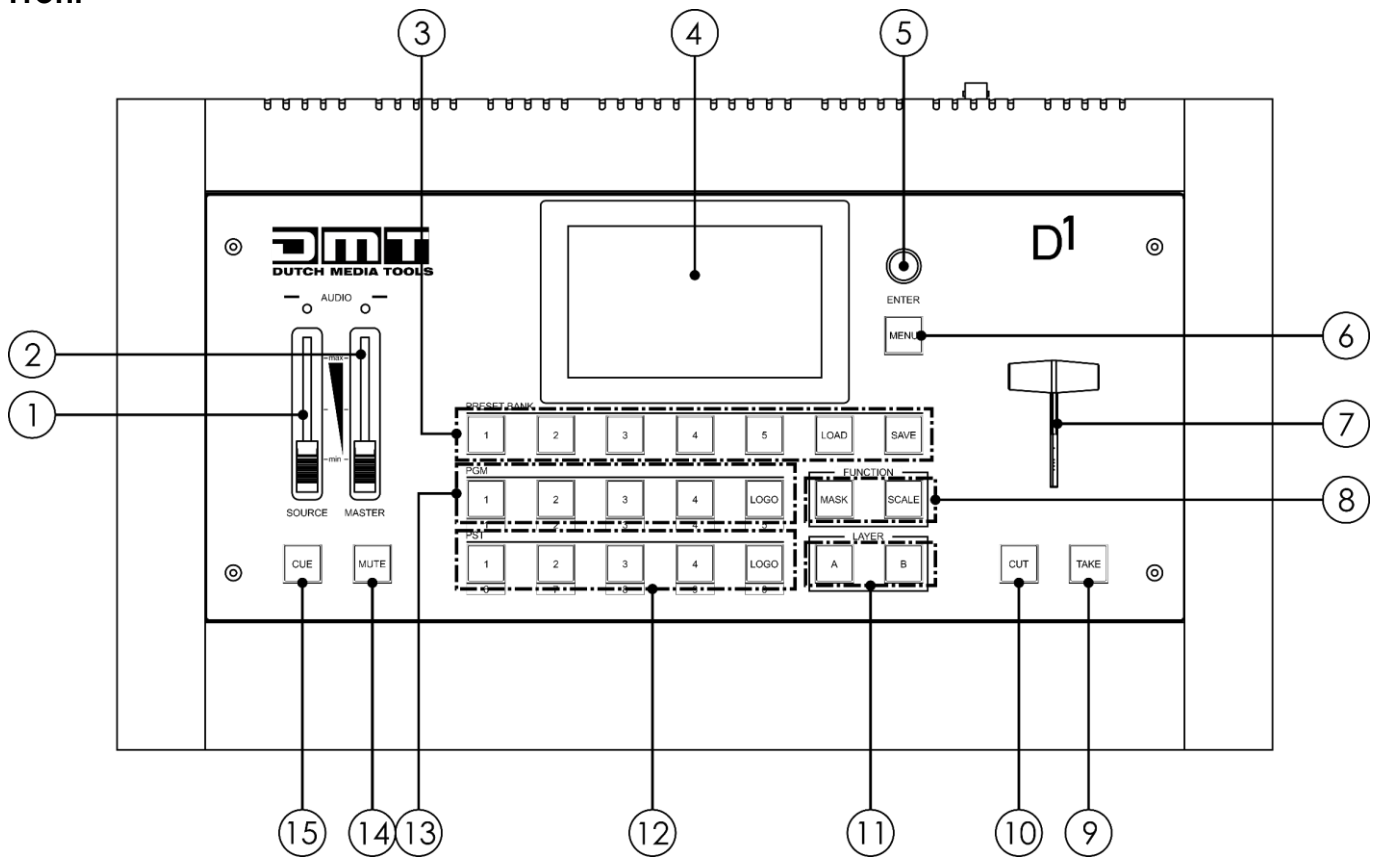

Fig. 01

- 01) Audio source fader
Move the fader to adjust the input volume. The CUE button (15) must be lit for this fader to work.
- 02) Master audio fader
Move the fader to set the volume for all the channels. The CUE button (15) must be lit for this fader to work.
- 03) Preset Bank section
 - SAVE button: Press the button to save the current settings on one of the 20 slots.
 - LOAD button: Press the button to load the previously saved settings.
 - 1-5 page buttons: Press the buttons to select the desired memory bank.
- 04) LCD touch screen display
- 05) Menu control
Press and turn the control to select, set and confirm settings.
- 06) MENU button
Press the button to open main menu or to return to the previous screen(s).
- 07) T-Bar
Move the bar to transition between the buses.
- 08) Function buttons
 - MASK button: Press the button to key the video into special shapes.
 - SCALE button: Press the button to set PIP in the PST window. Press the layer buttons (11) to disable PIP.
- 09) TAKE button
Press the button to seamlessly switch between input sources, with transition effects. It is possible to set the transition time. See page 23 for more information.
- 10) CUT button
Press the button to switch between input sources, without transition.
- 11) Layer buttons A/B
Press these buttons in order to enable/disable layers. The buttons light green when a layer is selected, they blink in PST mode and are off when a layer is disabled.

- 12) PST output area
Press the 6–9 buttons to select a preview input source. The pressed button will light up:
- If a button is continuously on: This input is currently active and cannot be edited.
 - If a button is flashing: This input can be edited.
 - If a button is off: This input is not active.
- 13) PGM output area
Press the 1–4 buttons to select a live input source. The pressed button will light up.
- 14) MUTE button
Press the button to mute the audio output. The function is active when the button lights red.
- 15) CUE button
Press the button to select the audio monitor (PST or PGM). When the button is lit, it is possible to adjust the audio volume with the SOURCE **(01)** and MASTER **(02)** faders.

Back

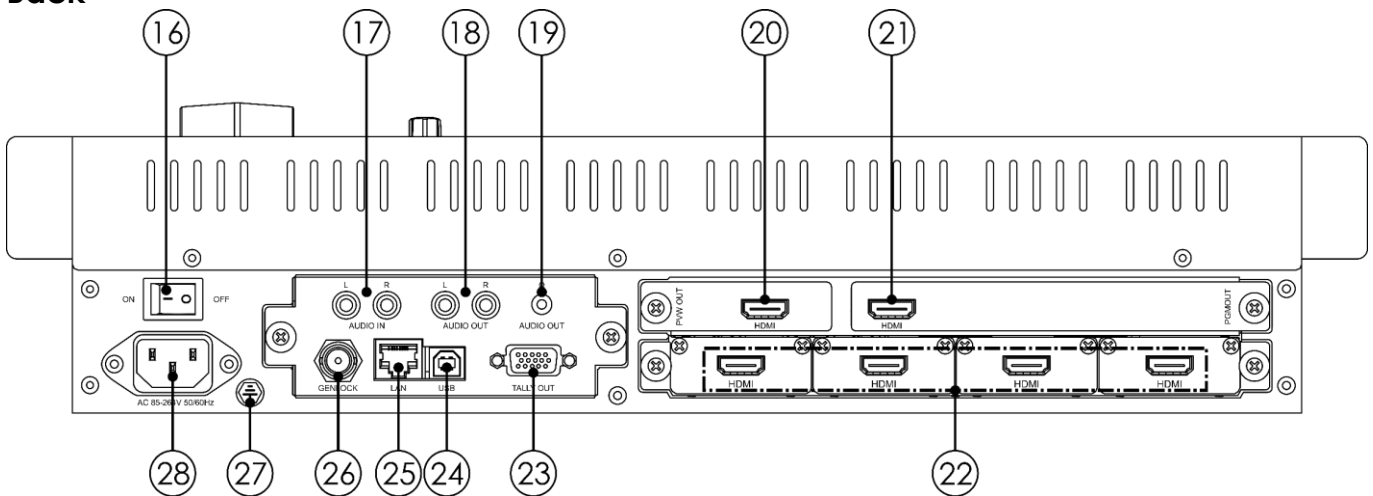

Fig. 02

- 16) Power switch ON/OFF
17) RCA audio IN
18) RCA audio OUT
19) 3,5 mm jack headphones connector OUT
20) PVW HDMI OUT
Preview output
21) PGM HDMI OUT
Program output
22) 4 x HDMI IN
23) Tally OUT
24) USB B interface (use for firmware upgrade)
25) RJ45 LAN connector IN (not functional at the moment)
26) Genlock BNC connector IN
27) Ground/earth connection
28) IEC power connector IN

Installation

Remove all packing materials from the D1 Videomixer. Check that all foam and plastic padding is removed. Connect all cables.

**Do not supply power before the whole system is set up and connected properly.
Always disconnect from electric mains power supply before cleaning or servicing.
Damages caused by non-observance are not subject to warranty.**

 **Do not HOT plug HDMI.** 

 **Turn OFF your device before connecting any cables!**
Otherwise your device can become damaged and your warranty will become void. 

Setup and Operation

Follow the directions below, as they pertain to your preferred operation mode.
Before plugging the unit in, always make sure that the power supply matches the product specification voltage. Do not attempt to operate a 110 V specification product on 240 V power, or vice versa.

Control Panel

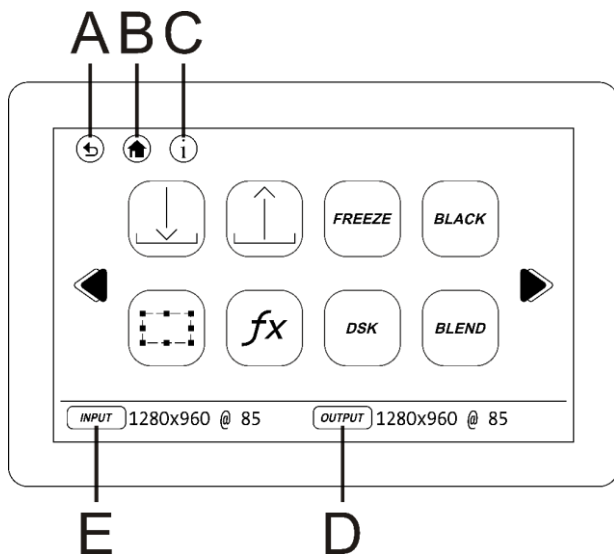

- A) RETURN button
- B) HOME button
- C) INFO button
- D) Output information
- E) Input information

Fig. 03

Menu Overview

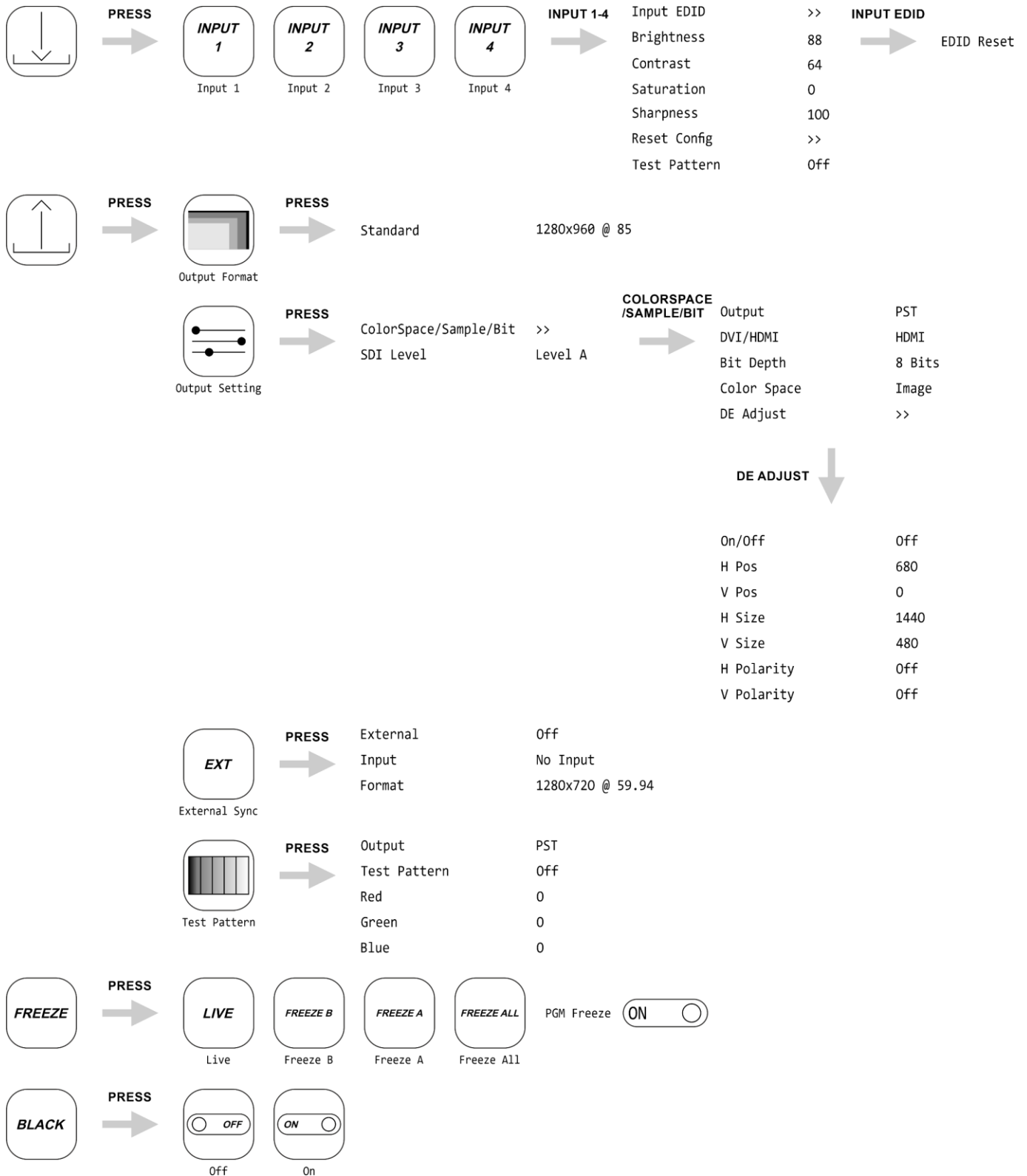

D1 Videomixer

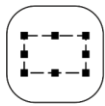

PRESS →

Full Screen	Off
H Pos	320
V Pos	240
H Size	640
V Size	480
H/V Size	640
Reset	>>
Crop H Pos	0
Crop V Pos	0
Crop H Size	1920
Crop V Size	1080
Reset	>>



PRESS →

			<i>FADE</i>				
<-[]->	L->R	T->B	FADE	LT->RB	<-+>	L->R	B->T
L<-M->R	T<-M->B	->+<-	->	->[]<-	<-0->		



PRESS →

DSK	Off
Preset	User
Mode	Key In
Alpha	112
Red Min	112
Red Max	255
Green Min	255
Green Max	15
Blue Min	0
Blue Max	15



PRESS →

On/Off	Off
Blending Width	1



→

Logo Present	No Logo
On/Off	On
H Pos	1024
V Pos	832
Delete Logo	No Logo
Still Present	1
On/Off	Off
H Pos	0
V Pos	0
Delete Still	1



PRESS →

Mask	Hexagons5
Mask Size	5
On/Off	Off
Mask&PIC Pos X	3770
Mask&PIC Pos Y	0
Mask Pos X	3770
Mask Pos Y	0
PIC Pos X	320
PIC Pos Y	240

D1 Videomixer

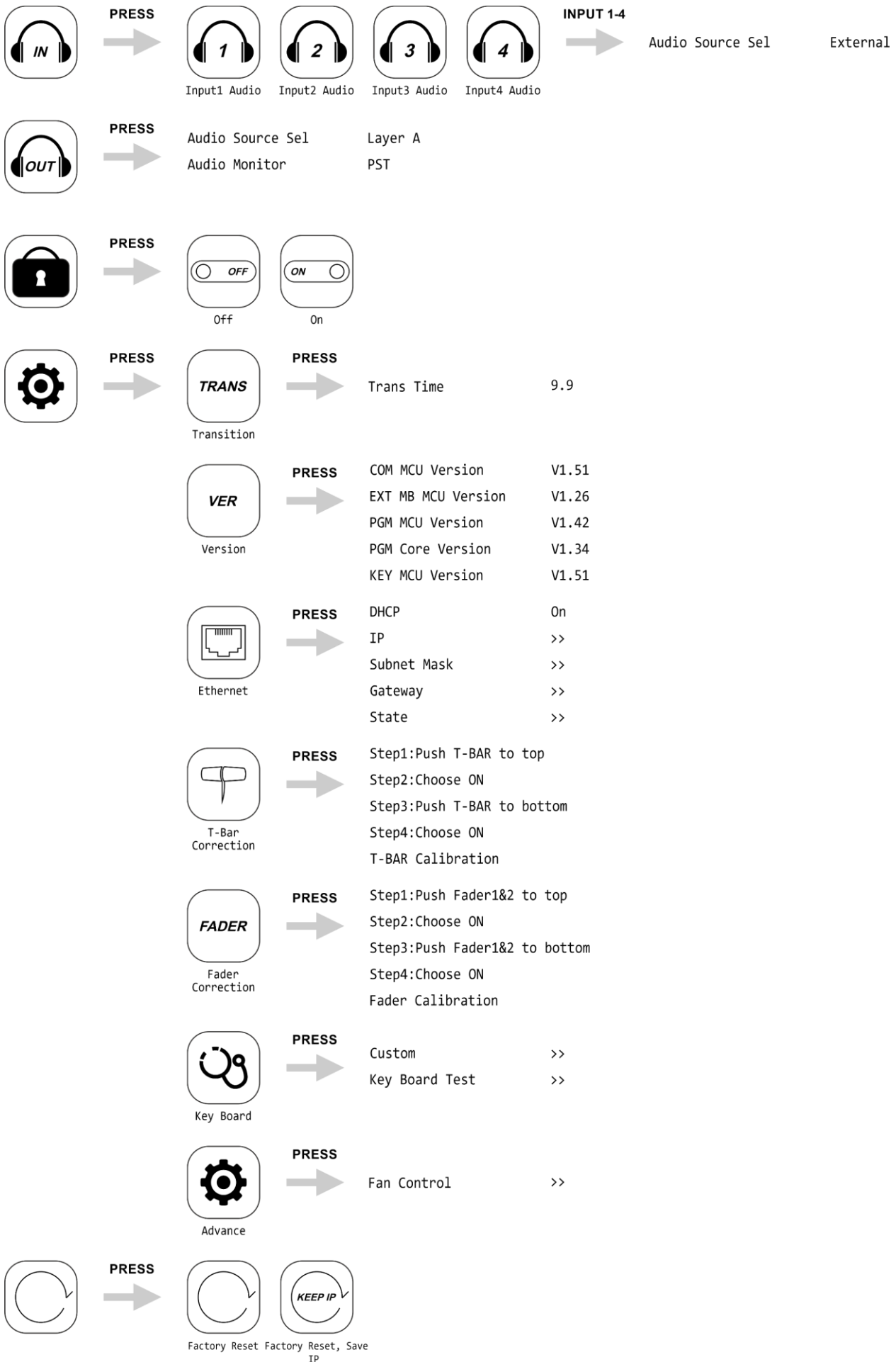

Main Menu Options

The display is equipped with a touch screen, which means that the options can be accessed in 2 ways:

- By turning (to select/adjust the values) and pressing the menu control (to open/confirm).
- By touching the options directly on the screen.

Therefore, the instructions included in this user manual will contain words as: select, adjust, open and confirm.

Please note, that some options can be accessed ONLY by turning/pressing the control and the touch screen will not work.

01) At start-up, the display will show 2 screens:

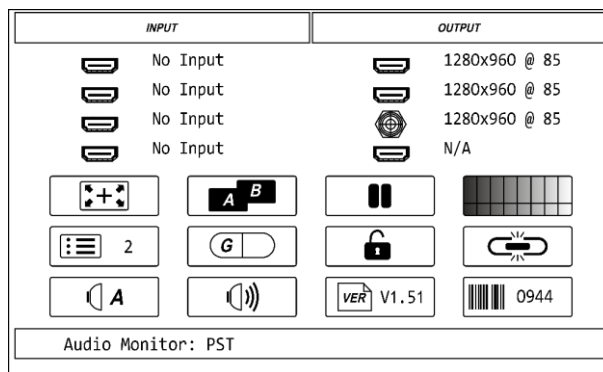

02) Press the MENU button (06) or turn the menu control (05) to enter the main menu. The display will show:

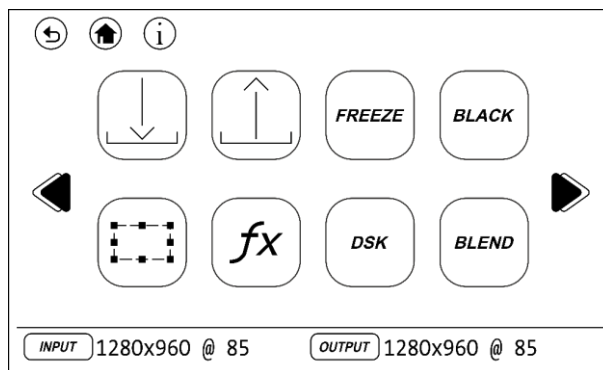

03) Turn the menu control (05) to toggle through the submenus (or touch the white arrows located on the opposite sides of the touch screen).

04) Press the menu control (05) to open the selected submenu (or touch its icon on the touch screen).

05) See page 14 for the available submenus.

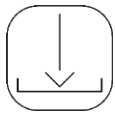

1. Input

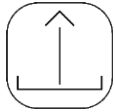

2. Output



3. Freeze



4. Black

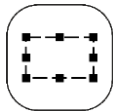

5. Scale



6. Transition



7. DSK



8. Blend



9. Logo



10. Mask



11. Audio Input



12. Audio Output



13. Front Panel Lock



14. Settings

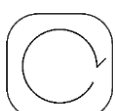

15. Factory Reset

1. Input

In this menu you can set the input settings.

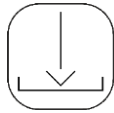

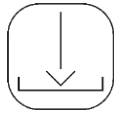
01) While in main menu, select  and open the menu. The display will show:

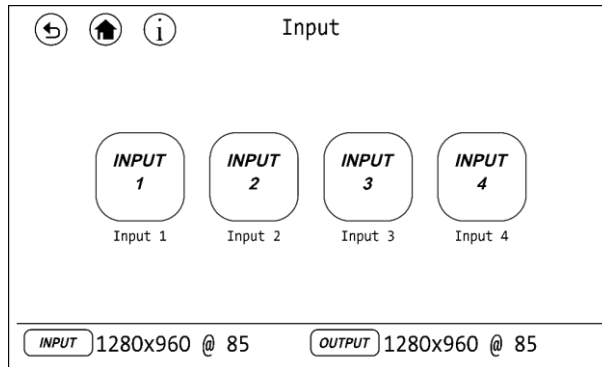

02) Select one of the 4 inputs and enter its settings menu.

03) In the settings menu, select/adjust one of the following settings:

- INPUT EDID: The display will show EDID RESET. Confirm and select YES or NO, in order to reset EDID. Confirm your choice.
- BRIGHTNESS: Set the brightness (0–100).
- CONTRAST: Set the contrast (0–100).
- SATURATION: Set the saturation (0–100).
- SHARPNESS: Set the sharpness (0–100).
- RESET CONFIG: Confirm and select YES or NO, in order to reset the configuration. Confirm your choice.
- TEST PATTERN: Select OFF or COLOR BAR and confirm your choice.

2. Output

In this menu you can set the output settings.

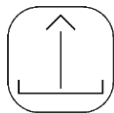

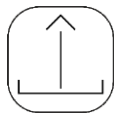
01) While in main menu, select  and open the menu. The display will show:

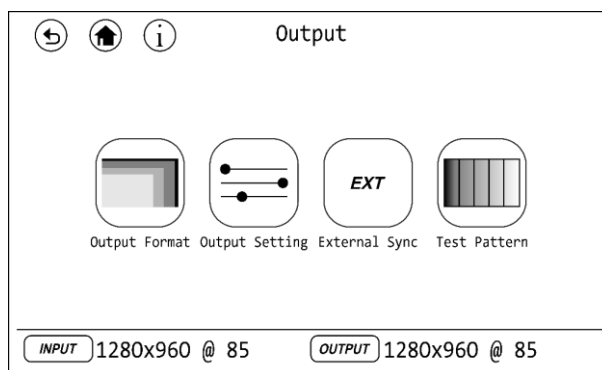

02) Select one of the 4 submenus:

- OUTPUT FORMAT
- OUTPUT SETTING
- EXTERNAL SYNC
- TEST PATTERN

2.1. Output Format

In this menu you can set the output format settings.

- 01) Press the menu control **(05)** to open the menu.
- 02) **Touch** the list of screen resolutions. The display will show 'This operation will clear saved banks.'
- 03) Select YES.
- 04) Turn the menu control **(05)** to select one of the following resolutions:

1024x768x60	1280x1024x75	1920x1080x50
1024x768x75	1280x1024x85	1920x1080x50
1024x768x85	1360x768x60	1920x1080x59,94
1152x864x75	1366x768x60	1920x1080x60
1280x768x60;	1440x900x60	1920x1080x59,94i
1280x800x60	1400x1050x60	1920x1080x50i
1280x960x60;	1280x720x50	1920x1080x60i
1280x960x85	1280x720x59,94	720x576x50i
1280x1024x60	1280x720x60	720x480x60i

- 05) Confirm your choice.

2.2. Output Setting

In this menu you can set the output settings.

- 01) Select/adjust one of the 2 settings:
 - COLORSPACE/SAMPLE/BIT: For more information, see 2.2.1. page 16.
 - SDI LEVEL: Select A or B.

2.2.1. ColorSpace/Sample/Bit

- 01) Select/adjust the following settings:
 - OUTPUT PORT: Select PST or PGM.
 - DVI/HDMI: Select DVI or HDMI.
 - BIT DEPTH: Select 8 bits (or 10 bits, only if HDMI is selected).
 - COLOR SPACE: Select IMAGE or VIDEO.
 - DE ADJUST: When black spots appear on the sides of the screen, use this function to shift the black out of the screen. Select/adjust the following settings:
 - ON/OFF: Enable/disable DE.
 - H POS: Set the horizontal position.
 - V POS: Set the vertical position.
 - H SIZE: Set the width.
 - V SIZE: Set the height.
 - H POLARITY: Enable/disable horizontal polarity. Select ON/OFF.
 - V POLARITY: Enable/disable vertical polarity. Select ON/OFF.

2.3. External Sync

In this menu you can set the external sync, in order to avoid performance glitches. It is important when working with multiple cameras.

- 01) Select/adjust one of the 3 settings:
 - EXTERNAL: Enable/disable the external sync. Select ON/OFF.
 - INPUT: It shows the current input source. If there are no available inputs, the display will read 'No Input.'
 - FORMAT: Select one of the 2 resolutions (1280x720x59,94 or 1920x1080x59,94).

2.4. Test Pattern

In this menu you can set the test pattern settings.

- 01) Select/adjust one of the 5 settings:
 - OUTPUT: Select PST or PGM.
 - TEST PATTERN: Select OFF, COLOR BAR or SOLID COLOR.
 - RED: Set the brightness (0–255).
 - GREEN: Set the brightness (0–255).
 - BLUE: Set the brightness (0–255).

3. Freeze

In this menu you can set the freeze function.



01) While in main menu, select  and open the menu. The display will show:

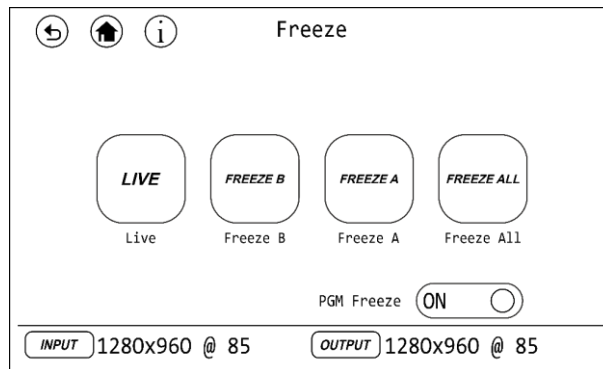

02) Select one of the 4 options:

- LIVE: Select this option to reactivate the currently frozen layers.
- FREEZE B: Select to freeze layer B.
- FREEZE A: Select to freeze layer A.
- FREEZE ALL: Select to freeze layers A and B.

03) **Touch** PGM FREEZE on the screen to switch PGM freeze ON/OFF.

4. Black

In this menu you can enable/disable blackout function. This function works for the program output and the preview output.

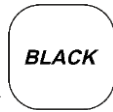

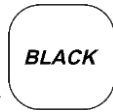
01) While in main menu, select  and open the menu. The display will show:

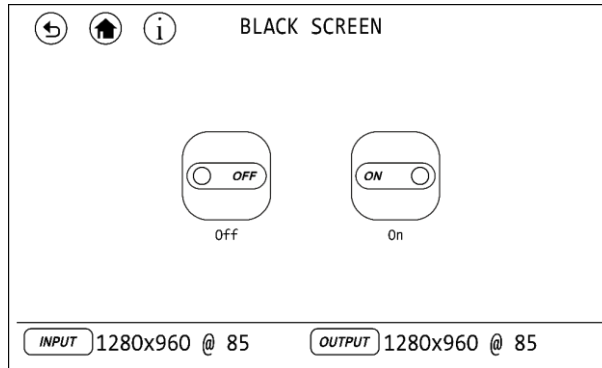

02) Select ON/OFF.

03) If you have chosen ON, the output will be blacked out.

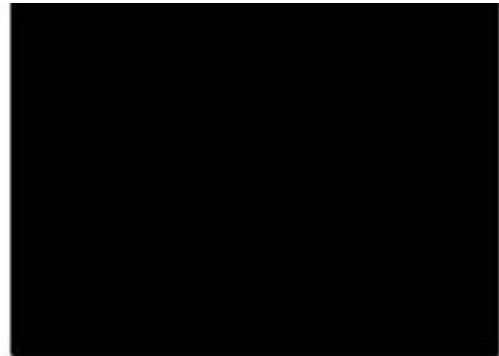

5. Scale

In this menu you can set the image scale size and image position settings.

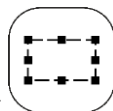

01) While in main menu, select  and open the menu.

02) Select/adjust the following settings:

- FULL SCREEN: Select ON/OFF to enable/disable full screen.
- H POS: Set the horizontal position.
- V POS: Set the vertical position.
- H SIZE: Set the width.
- V SIZE: Set the height.
- H/V SIZE: Set the size, keeping the aspect ratio.
- RESET: The display will read 'Do you want to reset scale parameter?' Select YES/NO and confirm.
- CROP H POS: Crop the horizontal position.
- CROP V POS: Crop the vertical position.
- CROP H SIZE: Crop the horizontal size.
- CROP V SIZE: Crop the vertical size.
- RESET: The display will read 'Do you want to reset crop parameter?' Select YES/NO and confirm.

6. Transition

In this menu you can set the desired transition effect.



- 01) While in main menu, select  and open the menu.
- 02) Select one of the following transition effects:



Iris box



Wipe to right



Wipe to bottom



Fade in/fade out



Wipe to bottom right



Iris cross



Wipe to left



Wipe to top



Center split horizontal



Center split vertical



Cross inwards

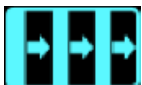

Blinds vertical



Box inwards



Iris round

- 03) Press the TAKE button **(09)** or move the T-bar **(07)** to apply the selected transition effect.

7. DSK

In this menu you can set the DSK function. **This function only works for the layer B.**



01) While in main menu, select  and open the menu.

02) Select/adjust the following settings:

- DSK: Select ON/OFF to enable/disable the DSK function.
- PRESET: Select the desired background color (USER, BLACK BACKGROUND, WHITE BACKGROUND, RED BACKGROUND, GREEN BACKGROUND or BLUE BACKGROUND).
- MODE: Select the desired mode:
 - KEY IN: The color set in PRESET will be cut out. The other colors will remain unchanged.
 - KEY OUT: The color set in PRESET will remain unchanged. The other colors will cut out.
- ALPHA: Set the alpha parameter (0–128).
- RED MIN: Set the minimum value of the red color (0–255).
- RED MAX: Set the maximum value of the red color (0–255).
- GREEN MIN: Set the minimum value of the green color (0–255).
- GREEN MAX: Set the maximum value of the green color (0–255).
- BLUE MIN: Set the minimum value of the blue color (0–255).
- BLUE MAX: Set the maximum value of the blue color (0–255).

8. Blend

In this menu you can set the Blend function. **This function only works for the layer B.**



01) While in main menu, select  and open the menu.

02) Select/adjust the following settings:

- ON/OFF: Select ON/OFF to enable/disable the Blend function.
- BLENDING WIDTH: Set the blending width (1–90).

Example: BLENDING WIDTH is set to 50.



9. Logo

In this menu you can set the logo. For more information about how to create a logo, see pages 29–31.

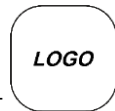

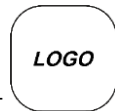
01) While in main menu, select  and open the menu.

02) Select/adjust the following settings:

- LOGO PRESENT: Select a logo.
- ON/OFF: Enable/disable the logo.
- H POS: Set the horizontal position of the logo.
- V POS: Set the horizontal position of the logo.
- DELETE LOGO: Delete the previously selected logo.
- STILL PRESENT: Select a still.
- ON/OFF: Enable/disable the still.
- H POS: Set the horizontal position of the still.
- V POS: Set the vertical position of the still.
- DELETE STILL: Delete the previously selected still.

10. Mask

In this menu you can set the mask.



01) While in main menu, select  and open the menu.

02) Select/adjust the following settings:

- MASK: Select the desired mask (DIAMOND, ROUND, HEART, STAR, TRI ANGLE, OVAL, HEXAGONS, PENTAGON, 4 POINT STAR, 6 POINT STAR, LIGHTNING, CRESCENT LEFT, CRESCENT RIGHT). See the pictures below.
- MASK SIZE: Set the mask size (1–6).
- ON/OFF: Enable/disable the mask.
- MASK&PIC POS X: Set the horizontal position of the mask and picture.
- MASK&PIC POS Y: Set the vertical position of the mask and picture.
- MASK POS X: Set the horizontal position of the mask.
- MASK POS Y: Set the vertical position of the mask.
- PIC POS X: Set the horizontal position of the picture.
- PIC POS Y: Set the vertical position of the picture.

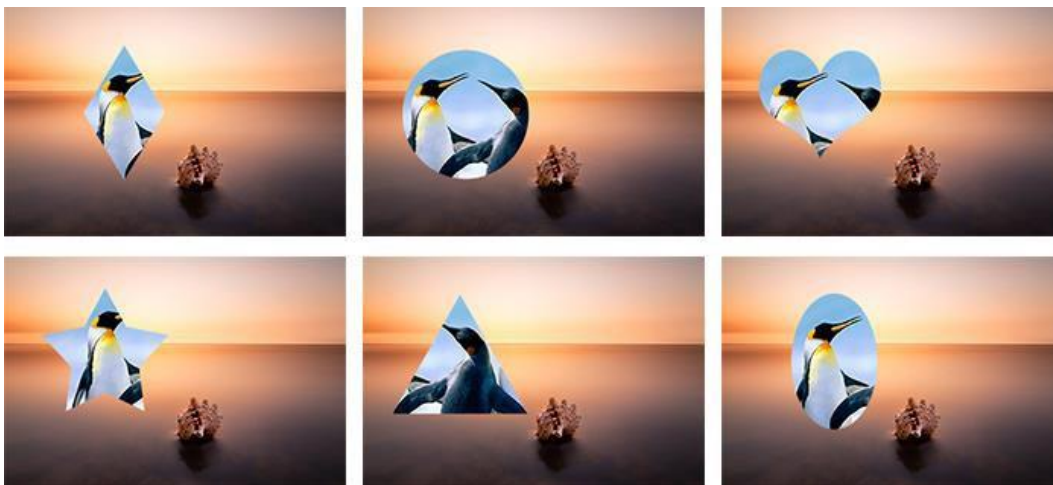

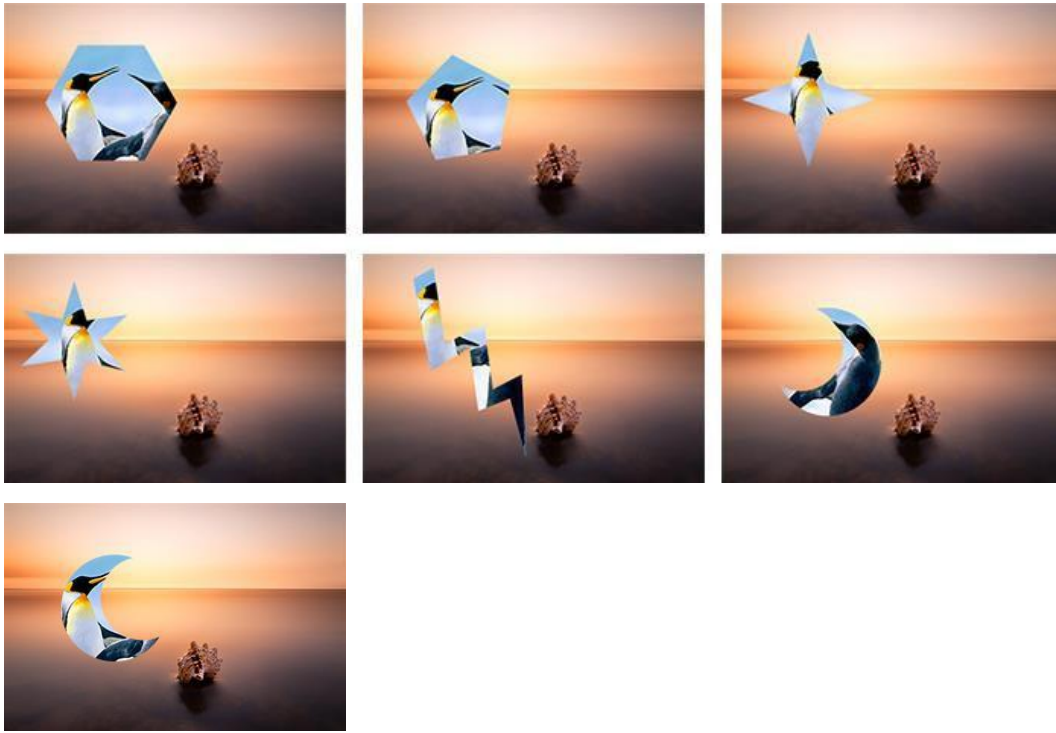

11. Audio Input

In this menu you can set the audio input settings.



01) While in main menu, select  and open the menu. The display will show:

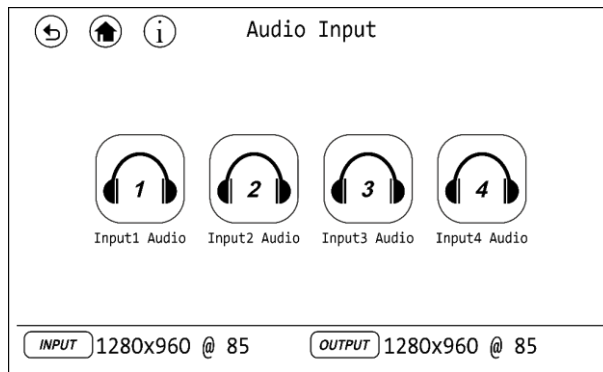

- 02) Select one of the 4 audio inputs and enter its settings menu.
- 03) In the settings menu, select/adjust the following setting:
 - AUDIO SOURCE SEL: Set the audio source (EMBEDDED or EXTERNAL).

12. Audio Output

In this menu you can set audio output settings.



- 01) While in main menu, select  and open the menu.
- 02) Select/adjust the following settings:
 - AUDIO SOURCE SEL: Set the audio source (LAYER A or LAYER B).
 - AUDIO MONITOR: Set the audio monitor (PST or PGM).

13. Front Panel Lock

In this menu you can set the front panel lock.



- 01) While in main menu, select  and open the menu.
- 02) Select ON/OFF to enable/disable the front panel lock.
- 03) In order to unlock the front panel, press and hold down the menu button **(06)** for 3 seconds.

14. Settings

In this menu you can set the device's general settings.



- 01) While in main menu, select  and open the menu. The display will show:

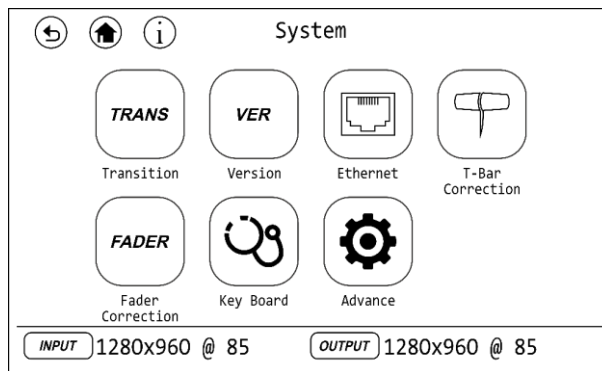

- 02) Select one of the 7 submenus:

- TRANSITION
- VERSION
- ETHERNET
- T-BAR CORRECTION
- FADER CORRECTION
- KEY BOARD
- ADVANCE

14.1. Transition

In this menu you can set the transition time between sources.

- 01) Select/adjust the following setting:
 - TRANS TIME: Transition time (0,0–9,9 seconds)

14.2. Version

In this menu you can view the version of the currently installed software.

- 01) The display will show:

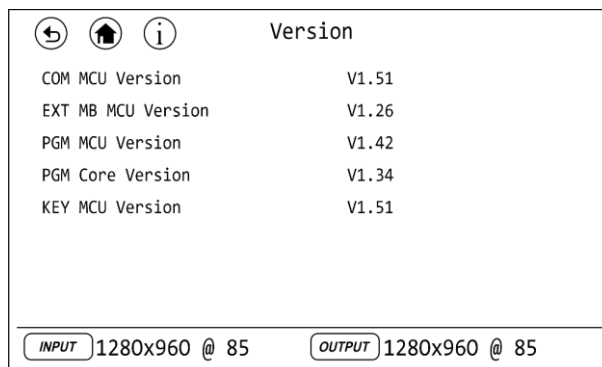

14.3. Ethernet

In this menu you can set the Ethernet settings.

01) Select/adjust one of the 5 settings:

- DHCP: Select ON/OFF. It must be set to ON for the user to be able to set the IP address, subnet mask, gateway and state.
- IP
- SUBNET MASK
- GATEWAY
- STATE

14.3.1. IP

In this menu you can set the IP address.

01) The display will show:

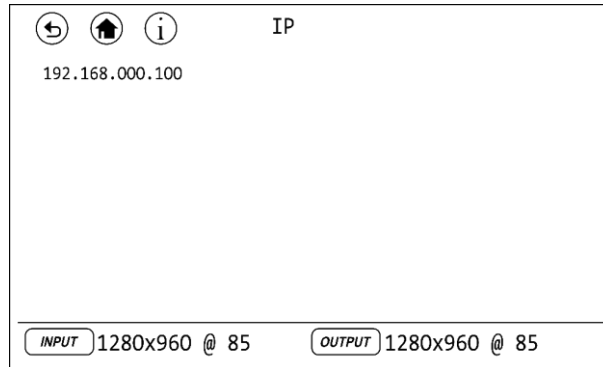

02) Turn the menu control **(05)** until the current IP address lights up.

03) Press the menu control **(05)** to be able to edit the IP address.

04) Turn the menu control **(05)** to edit the currently selected section of the IP address (the currently selected section will be underlined).

05) Press the menu control **(05)** to save changes.

06) Repeat steps 4–5 to edit the remaining sections of the IP address.

14.3.2. Subnet Mask

In this menu you can set the subnet mask.

01) The display will show:

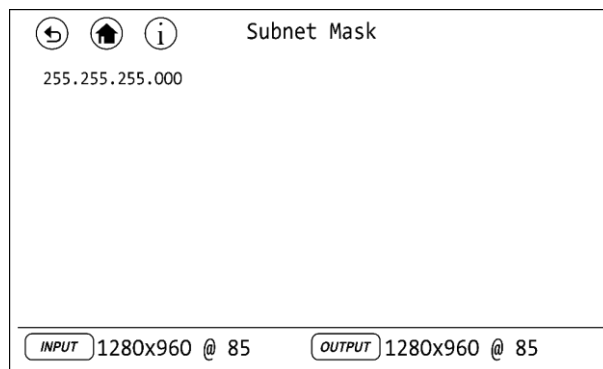

02) Turn the menu control **(05)** until the current subnet mask lights up.

03) Press the menu control **(05)** to be able to edit the subnet mask.

04) Turn the menu control **(05)** to edit the currently selected section of the subnet mask (the currently selected section will be underlined).

05) Press the menu control **(05)** to save changes.

06) Repeat steps 4–5 to edit the remaining sections of the subnet mask.

14.3.3. Gateway

In this menu you can set the gateway.

01) The display will show:

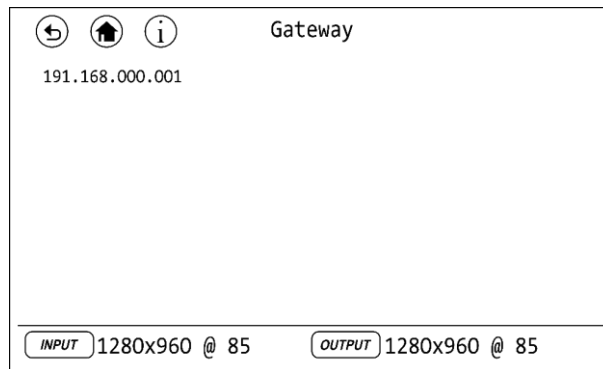

- 02) Turn the menu control **(05)** until the current gateway lights up.
- 03) Press the menu control **(05)** to be able to edit the gateway.
- 04) Turn the menu control **(05)** to edit the currently selected section of the gateway (the currently selected section will be underlined).
- 05) Press the menu control **(05)** to save changes.
- 06) Repeat steps 4–5 to edit the remaining sections of the gateway.

14.3.4. State

In this menu you can view the current Ethernet status. It is not possible to adjust settings in this menu.

01) The display will show:

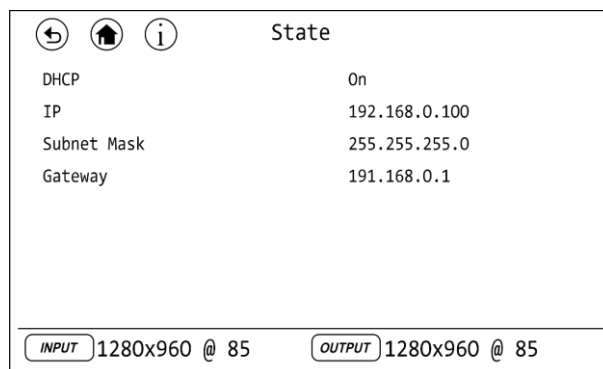

14.4. T-Bar Correction

In this menu you can calibrate the T-bar.

- 01) Move the T-bar to the top.
- 02) Select STEP2: CHOOSE ON and set it to ON.
- 03) Move the T-bar to the bottom.
- 04) Select STEP4: CHOOSE ON and set it to ON.
- 05) The display will read "Calibration succeeded!" which means that the calibration is complete.

14.5. Fader Correction

In this menu you can calibrate the source and master faders.

- 01) Move the source and master faders to the top.
- 02) Select STEP2: CHOOSE ON and set it to ON.
- 03) Move the source and master faders to the bottom.
- 04) Select STEP4: CHOOSE ON and set it to ON.
- 05) The display will read "Calibration succeeded!" which means that the calibration is complete.

14.6. Key Board

In this menu you can set the keyboard settings.

01) Select/adjust one of the 2 settings:

- CUSTOM
- KEY BOARD TEST

14.6.1. Custom

In this menu you can assign different functions to the MASK, PGM LOGO and PST LOGO buttons.

01) Select/adjust one of the 3 settings:

- MASK:
 - SELF: Press the MASK button **(08)** to set the output's shape and size.
 - BLACK: Press the MASK button **(08)** to black the output out.
 - FS: Press the MASK button **(08)** to enable/disable full-screen output.
- PGM LOGO:
 - SELF: Press the LOGO button in the PGM section **(13)** to set the PGM logo properties.
 - PGM FREEZE: Press the LOGO button in the PGM section **(13)** to set freeze the PGM output.
- PST LOGO:
 - SELF: Press the LOGO button in the PST section **(12)** to set the PST logo properties.
 - PST FREEZE: Press the LOGO button in the PST section **(12)** to set freeze the PST output.

14.6.2. Key Board Test

In this menu you can test the keyboard.

01) Select/adjust one of the 2 settings:

- LED LIGHT TEST: Select ON/OFF. If you have chosen ON, all the buttons on the device will light up, in order to test if the LEDs function properly.
- KEY VALUE: Select this option and then press any button on the device. The display will show the name of the pressed button. If the name of a button does not appear on the display, it means that the device (or the button) is broken.

14.7. Advance

In this menu you can set and view the cooling fan's parameters.

01) Select FAN CONTROL.

02) Select/adjust one of the 3 settings:

- AUTO SPEED: Select ON/OFF.
- CURRENT SPEED: Set the desired fan speed (20–100 %, from slow to fast).
- TEMPERATURE(°C): You can view the current device's temperature.

15. Factory Reset

In this menu you can restore the default factory settings.

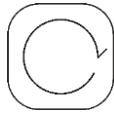

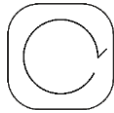
01) While in main menu, select  and open the menu. The display will show:

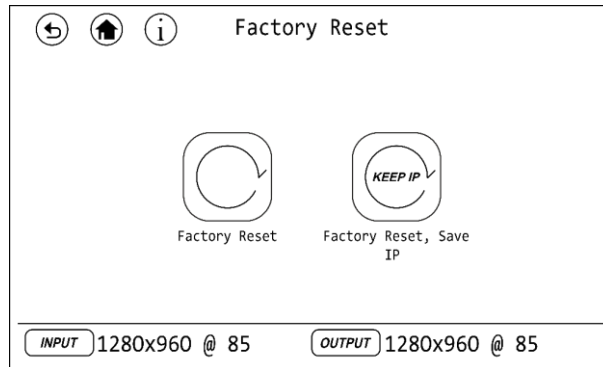

02) Select one of the 2 options:

- **FACTORY RESET:** Select to restore default factory settings.
- **FACTORY RESET, SAVE IP:** Select to restore default factory settings and keep the current IP address.

03) After you have selected one of the 2 options, the display will ask you to confirm your choice. Select YES/NO.

Operations

Start-up

- 01) Make sure that the D1 Videomixer is OFF.
- 02) Connect the video sources to the HDMI inputs **(22)**.
- 03) Turn all video sources ON.
- 04) Turn the D1 Videomixer ON.
- 05) Press one of the 6–9 buttons **(12)** to see the selected source on the preview HDMI output.
- 06) Press the TAKE **(09)** or CUT **(10)** button or move the T-bar **(07)** in order to send the selected video source from the PST to the PGM output.

Layering/PIP/MASK/SCALE

These functions work only in PVW (preview) mode.

- 01) Press the A button **(11)** to select the source for PIP layer 1. Press one of the 6–9 buttons **(12)** to select the input source.
- 02) Press the B button **(11)** to select the source for PIP layer 2. Press one of the 6–9 buttons **(12)** to select the input source.
- 03) Press the A or B button **(11)**. The button of the selected INPUT is now flashing.
- 04) Press the desired PST button **(12)**.
- 05) Press the MASK or SCALE button **(08)** to set the parameters. See pages 18 and 21 for more information.
- 06) Press the TAKE **(09)** or CUT **(10)** button or move the T-bar **(07)** in order to send the selected and edited video source from the PST to the PGM output.

Saving Presets

It is possible to save up to 20 views containing current parameters and settings. The memory is divided into 4 pages, 5 banks each.

01) Press the SAVE button located in the Preset Bank section **(03)**. The display will show:

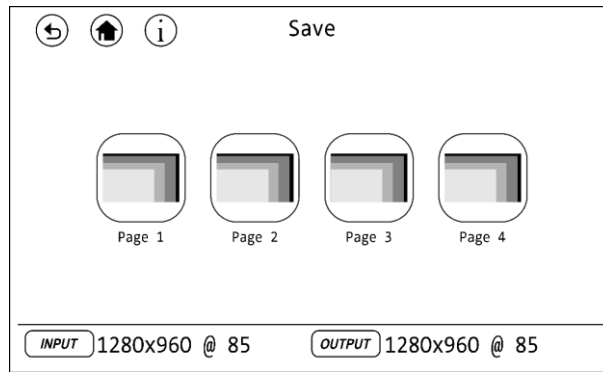

02) Select one of the 4 pages.

03) The buttons 1–5 in the Preset Bank section **(03)** will light green:

- If a button is flashing: This bank has already been used and saving a preset on this bank means that you need to overwrite an existing preset.
- If a button is continuously on: This bank has not been used yet and it is possible to save a preset without overwriting any data.

04) Press one of the 1–5 buttons in the Preset Bank section **(03)** to save a preset.

Loading Presets

01) Press the LOAD button located in the Preset Bank section **(03)**. The display will show:

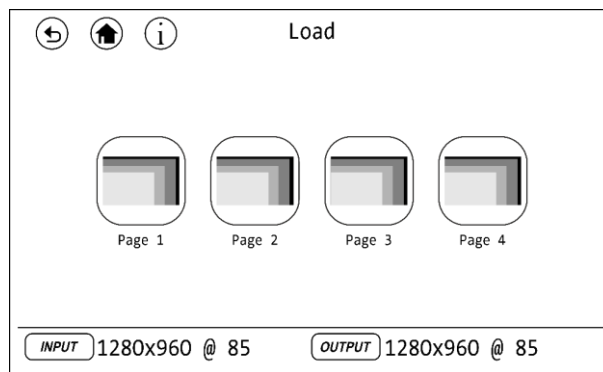

02) Select one of the 4 pages.

03) The buttons 1–5 in the Preset Bank section **(03)** will light green:

- If a button is flashing: This bank is currently active.
- If a button is continuously on: This bank contains a saved preset and you need to press its button to activate it.
- If a button is off: This bank does not contain any preset. Therefore, it cannot be loaded.

Creating a Custom Logo

It is possible to create a custom logo by means of the dedicated software.

- 01) Turn the D1 Videomixer off.
- 02) Loosen the mounting screws and remove (pull out) the indicated module:

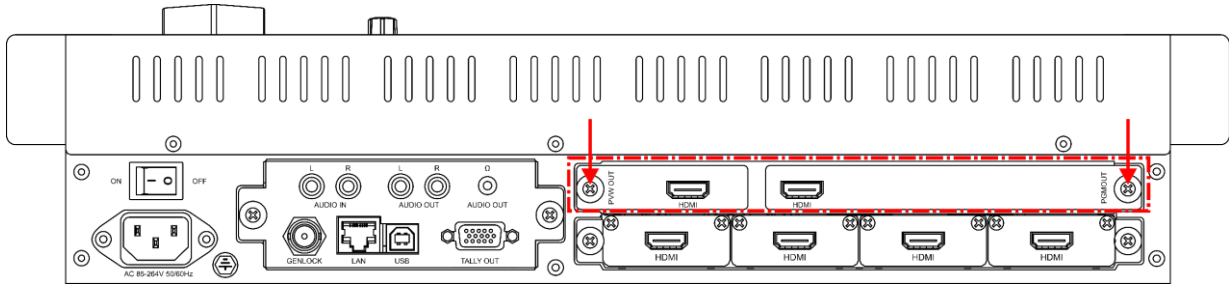

- 03) Remove the microSD card from the housing and connect it to your PC. **The card should be FAT32 formatted.**

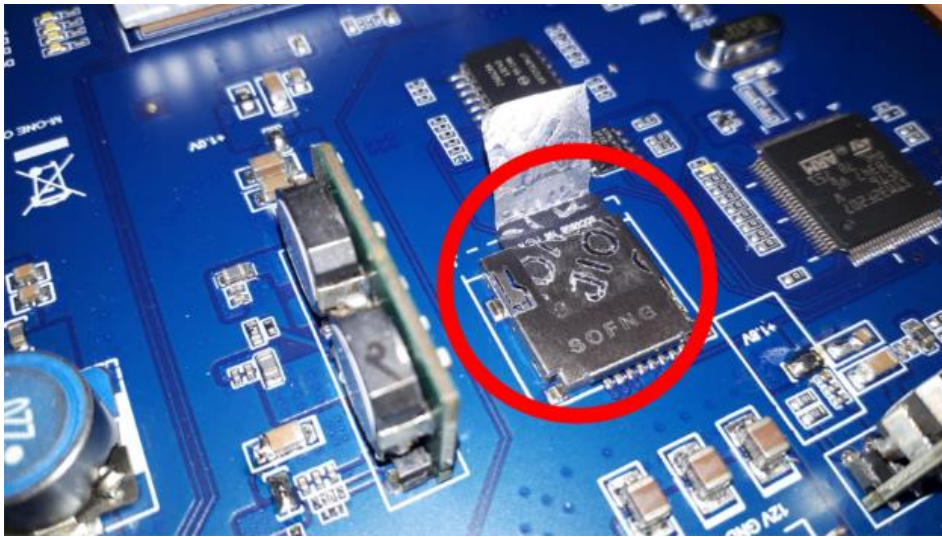

- 04) Install XTOOL software on your PC.
- 05) Double-click the XTOOL shortcut on the desktop to start the software. The display will show:

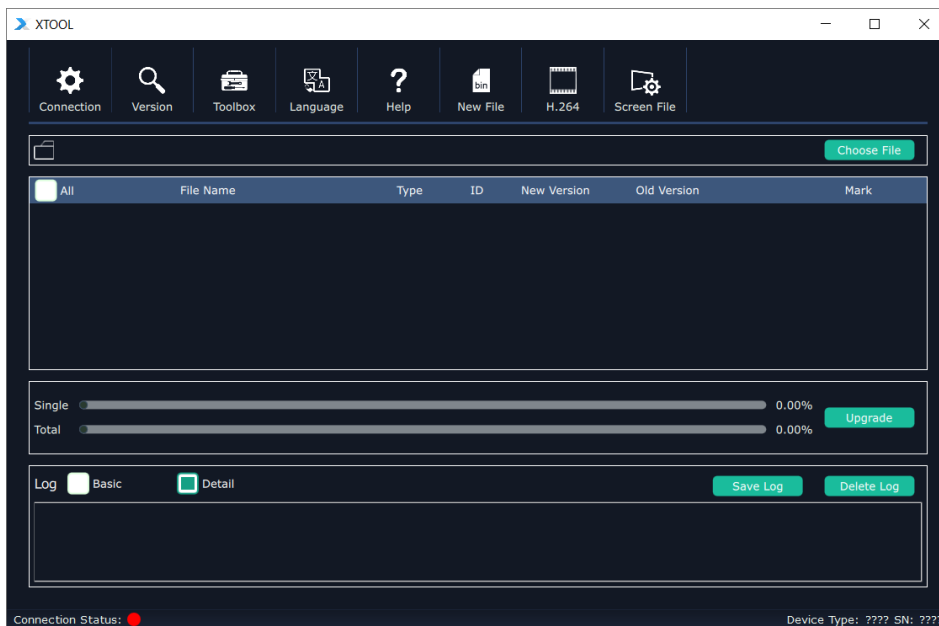

06) Click on "Toolbox" tab (at the top of the screen) and then on "Custom Logo". The display will show:



07) Using any raster graphics editor (e.g. MS Paint), create your desired logo and save it on your PC. The properties of a custom logo should be as follows:

- The picture format must be **24-bit BMP** and the size should not be larger than **256x128 pixels**.
- The picture background should be **solid-colored** (it is white by default).

08) In XTOOL software, click on "File (*BMP)" and select the previously created logo file.

09) Check "Transparency ON/OFF" option.

10) Click on "Background Color" and select the desired background color.

11) Click on "Create a Logo". The display will show:



12) Choose the correct file number (File No). The adjustment range is 1–50. When saving multiple logos, save them in the ascending order. It is not allowed to skip numbers.

13) Type in the name of your logo (File Name).

14) Click on "Select" and choose the "####*\LOGO" folder on the microSD card. Create such folder, if it does not exist.

Note: * "#####" stands for the card's drive letter on your PC, e.g. "J:/LOGO".

15) Click on "Confirm" to create a logo. The software will show "Created!"

16) The logo is now saved on the microSD card as LOGO_xxx.bin file, where "xxx" stands for the logo number.

17) Remove the microSD card from the PC, place it in the D1 Videomixer and replace the previously removed module.

18) Turn the D1 Videomixer on.

19) Select and edit the logo. For more information, see 9. Logo, page 21.

PST/PGM Logo

In this menu you can set the properties of the PST logo or the PGM logo.

- 01) Press the LOGO button in the PGM section **(13)** (to set the PGM logo properties) or press the LOGO button in the PST section **(12)** (to set the PST logo properties).
- 02) Select/adjust the following settings:
 - LOGO: Select a logo.
 - ON/OFF: Enable/disable the logo.
 - H POS: Set the horizontal position of the logo.
 - V POS: Set the horizontal position of the logo.
 - DELETE LOGO: Delete the previously selected logo.

Maintenance

The DMT D1 Videomixer requires almost no maintenance. However, you should keep the unit clean. Disconnect the mains power supply and then wipe the cover with a damp cloth. Wipe the front panel clean with glass cleaner and a soft cloth. Do not use alcohol or solvents. Do not immerse in liquid. Keep connections clean. Disconnect electric power, and then wipe the video and audio connections with a damp cloth. Make sure connections are thoroughly dry before linking equipment or supplying electric power.

The operator has to make sure that safety-related and machine-technical installations are to be inspected by an expert after every year in the course of an acceptance test and by a skilled person once a year.

The following points have to be considered during the inspection:

- 01) All screws used for installing the device or parts of the device have to be tightly connected and must not be corroded.
- 02) There may not be any deformations on housings, fixations and installation spots.
- 03) Mechanically moving parts like axles, eyes and others may not show any traces of wearing.
- 04) The electric power supply cables must not show any damages or material fatigue.

Troubleshooting

This troubleshooting guide is meant to help solve simple problems.

If a problem occurs, carry out the steps below in sequence until a solution is found. Once the unit operates properly, do not carry out following steps.

If the D1 Videomixer does not operate properly, refer servicing to a technician.

Suspect two potential problem areas as: the power supply, the cables.

- 01) Power supply. Check if the unit is plugged into an appropriate power supply.
- 02) All cables. Please check all connections and all cables.
- 03) If all of the above appears to be O.K., plug the unit in again.
- 04) If you are unable to determine the cause of the problem, do not open the D1 Videomixer, as this may damage the unit and the warranty will become void.
- 05) Return the device to your DMT dealer.

No Output

Confirm if there is any input signal.

- 01) Go to OUTPUT -> EXTERNAL SYNC to see whether the input signal is detected. If the display shows "No Input," check the input source.
- 02) Connect a preview monitor to the HDMI output to check if there is output.

Screen Only Displays a Part of the Image

Signal needs to be scaled.

- 01) Go to SCALE menu and adjust the scale and crop settings.

Output Does Not Fill the Entire Screen

Resolution is incorrect.

01) Select the resolution which is larger than the screen width.

Black Spots Appear on the Sides of the Screen

Adjust DE deviation.

01) Go to OUTPUT -> OUTPUT SETTING and set DE ADJUST.

Product Specifications

Model:	D1 Videomixer
Input voltage:	100–240 V AC, 50/60 Hz
Power consumption:	65 W
Inputs:	4 x HDMI
Output program (PGM):	1 x HDMI
Output preview (PVW):	1 x HDMI
Input resolutions HDMI:	SMPTE: 625@25/50 PAL 525@29,97/59,94 NTSC 1080p@50/59,94/60 1080i@50/59,94/60 720p@50/59,94/60
Output resolutions:	VESA: 800x600@60 1024x768@60 1280x768@60 1280x1024@60 1600x1200@60 1920x1080@60 SMPTE: 480i 576i 625@25/50 PAL 525@29,97/59,94 NTSC 1080p@50/59,94/60 1080i@50/59,94/60 720p@50/59,94/60
Genlock Y In:	VESA: 800x600@60 1024x768@60 1280x768@60 1280x1024@60 1600x1200@60 1920x1080@60 Black Burst: 480i 576i 720p@50/59,94 1080i@50/59,94 1080p@50/59,94/60 1080psf@23,98/24
Grayscale processing:	12 bit
Processing engine:	10 bit
Layers:	2
DSK/Chroma-key:	Yes (foreground layer)
Blend:	Yes (foreground layer)
Mask:	Yes (foreground layer)
Transition effect:	Yes
Humidity:	10–90 %
Operating temperature:	-25 °C to +55 °C
Dimensions:	483 x 290 x 105 mm (LxWxH)
Weight:	5,7 kg

Design and product specifications are subject to change without prior notice.



Website: www.dutch-media-tools.com
Email: service@highlite.com

Dimensions

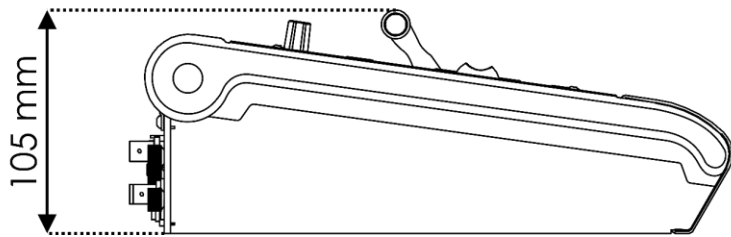
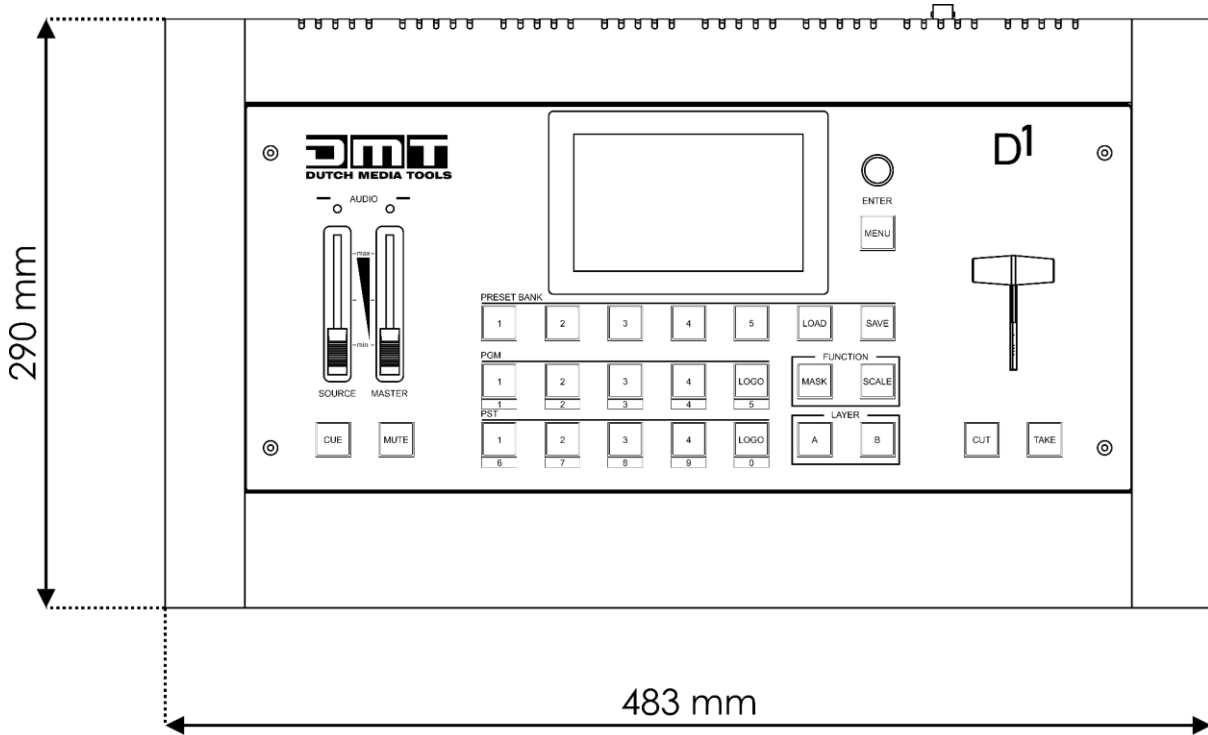



©2020 DMT