

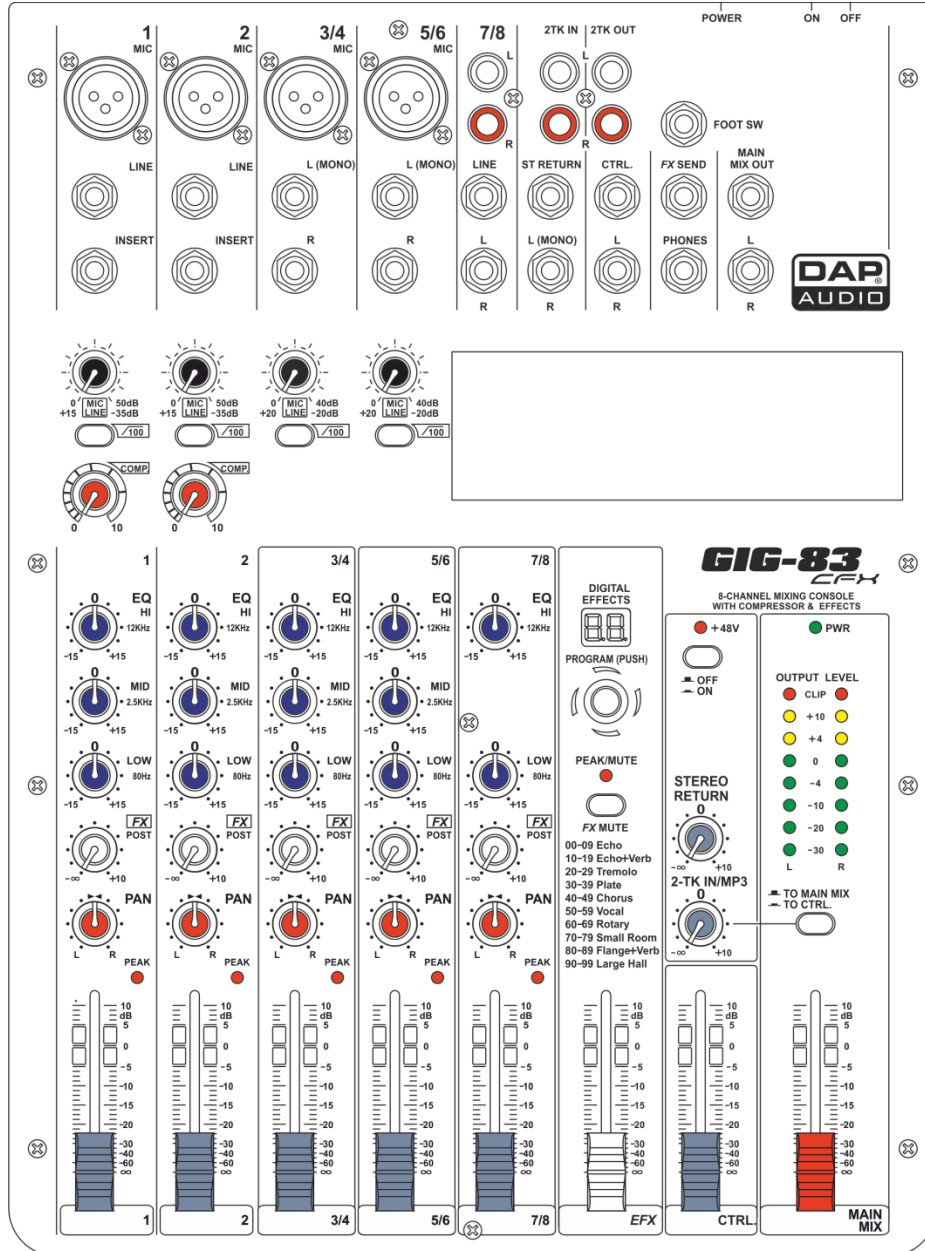

MANUAL



ENGLISH

GIG-83CFX

Order code: D2282

Table of contents

Warning	2
Unpacking Instructions.....	2
Safety Instructions	2
Operating Determinations	4
Return Procedure.....	4
Claims.....	4
Description of the device	5
Features	5
Overview	5
Installation	6
Introduction.....	6
Ready to start	6
Control Elements	7
Modules	12
Option One - SMP-S (Order code: D2290)	12
Option Two - SMP-R (Order code: D2291)	14
Option Three - Bluetooth Version 2.1 (Order code: D2292)	15
Installation and connection	16
Connection Cables	17
Block Diagram	18
Preset List GIG-83CFX	19
Technical Specifications	20
Notes	21
Dimensions	22

Warning



**FOR YOUR OWN SAFETY, PLEASE READ THIS USER MANUAL CAREFULLY
BEFORE YOUR INITIAL START-UP!**



Unpacking Instructions

Immediately upon receiving this product, carefully unpack the carton and check the contents to ensure that all parts are present and have been received in good condition. Notify the dealer immediately and retain packing material for inspection if any parts appear damaged from shipping or the carton itself shows signs of mishandling. Save the carton and all packing materials. In the event that a fixture must be returned to the factory, it is important that the fixture be returned in the original factory box and packing.

Your shipment includes:

- GIG-83CFX mixing console
- AC power adapter
- User Manual



CAUTION!
Keep this device away from rain and moisture!
Unplug mains lead before opening the housing!



Safety Instructions

Every person involved with the installation, operation and maintenance of this system has to:

- be qualified
- follow the instructions of this manual



CAUTION! Be careful with your operations.
With a dangerous voltage you can suffer
a dangerous electric shock when touching the wires!



Before you initial start-up, please make sure that there is no damage caused by transportation. Should there be any, consult your dealer and do not use the system.

To maintain perfect condition and to ensure a safe operation, it is absolutely necessary for the user to follow the safety instructions and warning notes written in this manual.

Please consider that damages caused by manual modifications to the system are not subject to warranty.

This system contains no user-serviceable parts. Refer servicing to qualified technicians only.

IMPORTANT:

The manufacturer will not accept liability for any resulting damages caused by the non-observance of this manual or any unauthorized modification to the system.

- Never let the power-cord come into contact with other cables! Handle the power-cord and all connections with the mains with particular caution!
- Never remove warning or informative labels from the unit.

- Never use anything to cover the ground contact.
- Never leave any cables lying around.
- Do not insert objects into air vents.
- Do not connect this system to a dimmer pack.
- Do not switch the system on and off in short intervals, as this would reduce the system's life.
- Do not open the device and do not modify the device.
- Do not drive the inputs with a signal level bigger, than required to drive the equipment to full output.
- Do not plug Mics into the console (or stage box) while Phantom Power is on. Also mute the monitor / Pa system when turning Phantom Power on or off. Allow the system to adjust for a couple of seconds, before setting the input gains.
- Only use system indoor, avoid contact with water or other liquids.
- Avoid flames and do not put close to flammable liquids or gases.
- Always disconnect power from the mains, when system is not used. Only handle the power-cord by the plug. Never pull out the plug by tugging the power-cord.
- Always operate the unit with the AC ground wire connected to the electrical system ground.
- Make sure you don't use the wrong kind of cables or defective cables.
- Make sure that the signals into the mixer are balanced, otherwise hum could be created.
- Make sure you use DI boxes to balance unbalanced signals; All incoming signals should be clear.
- Make sure that the available voltage is not higher than stated on the rear panel.
- Make sure that the power-cord is never crimped or damaged. Check the system and the power-cord from time to time.
- Please turn off the power switch, when changing the power cord or signal cable, or select the input mode switch.
- Extreme frequency boosts in connection with a high input signal level may lead to overdriving your equipment. Should this occur, it is necessary to reduce the input signal level by using the INPUT control.
- To emphasize a frequency range, you don't necessarily have to move its respective control upward; try lowering surrounding frequency ranges instead. This way, you avoid causing the next piece of equipment in your sound path to overdrive. You also preserve valuable dynamic reserve ("headroom")
- Avoid ground loops! Always be sure to connect the power amps and the mixing console to the same electrical circuit to ensure the same phase!
- If system is dropped or struck, disconnect mains power supply immediately. Have a qualified engineer inspect for safety before operating.
- If the system has been exposed to drastic temperature fluctuation (e.g. after transportation), do not switch it on immediately. The arising condensation water might damage your system. Leave the system switched off until it has reached room temperature.
- If your Dap Audio device fails to work properly, discontinue use immediately. Pack the unit securely (preferably in the original packing material) and return it to your Dap Audio dealer for service.
- Repairs, servicing and electric connection must be carried out by a qualified technician.
- For replacement use fuses of same type and rating only.
- WARRANTY: Till one year after date of purchase.



Disposing of this product should not be placed in municipal waste and should be separate collection.

Operating Determinations

- This device is not designed for permanent operation. Consistent operation breaks will ensure that the device will serve you for a long time without defects.
- The minimum distance between light-output and the illuminated surface must be more than 0.5 meter.
- The maximum ambient temperature $t_a = 45^\circ\text{C}$ must never be exceeded.
- The relative humidity must not exceed 50 % with an ambient temperature of 35°C .
- If this device is operated in any other way, than the one described in this manual, the product may suffer damages and the warranty becomes void.
- Any other operation may lead to dangers like short-circuit, burns, electric shock, crash, etc.

You endanger your own safety and the safety of others!



Return Procedure



Returned merchandise must be sent prepaid and in the original packing, call tags will not be issued. Package must be clearly labeled with a Return Authorization Number (RMA number). Products returned without an RMA number will be refused. Highlite will not accept the returned goods or any responsibility. Call Highlite 0031-455667723 or mail aftersales@highlite.nl and request an RMA prior to shipping the fixture. Be prepared to provide the model number, serial number and a brief description of the cause for the return. Be sure to properly pack fixture, any shipping damage resulting from inadequate packaging is the customer's responsibility. Highlite reserves the right to use its own discretion to repair or replace product(s). As a suggestion, proper UPS packing or double-boxing is always a safe method to use.

Note: If you are given an RMA number, please include the following information on a piece of paper inside the box:

- 1) Your name
- 2) Your address
- 3) Your phone number
- 4) A brief description of the symptoms

Claims

The client has the obligation to check the delivered goods immediately upon delivery for any shortcomings and/or visible defects, or perform this check after our announcement that the goods are at their disposal. Damage incurred in shipping is the responsibility of the shipper; therefore the damage must be reported to the carrier upon receipt of merchandise.

It is the customer's responsibility to notify and submit claims with the shipper in the event that a fixture is damaged due to shipping. Transportation damage has to be reported to us within one day after receipt of the delivery.

Any return shipment has to be made post-paid at all times. Return shipments must be accompanied with a letter defining the reason for return shipment. Non-prepaid return shipments will be refused, unless otherwise agreed in writing.

Complaints against us must be made known in writing or by fax within 10 working days after receipt of the invoice. After this period complaints will not be handled anymore.

Complaints will only then be considered if the client has so far complied with all parts of the agreement, regardless of the agreement of which the obligation is resulting.

Description of the device

Features

- Ultra-low noise discrete MIC Preamps with +48V Phantom Power.
- 2 MIC Input Channels with XLRs and balanced Line Input, Insert I/O and Compressor control.
- Low Cut for each MIC Input.
- 2 Stereo Input Channels with mono XLR Input and 1/4" TRS Jack.
- 1 Stereo Input Channel with RCA Jack and 1/4" TRS Jack input.
- 3-band EQ and Peak LEDs on each MIC channel.
- 2-band EQ and Peak LEDs on Stereo channels.
- AUX Send per channel for external effects and monitoring. FX send per channel for internal effects.
- 2-Track Input assignable to Main Mix or Control Room/Headphone Outputs.
- Unbalanced 1/4" TRS outputs, Control Room and Headphone Outputs.
- Built in 24-bit DSP effect with 100 presets.
- Optional MP3 player or Bluetooth player.

Overview

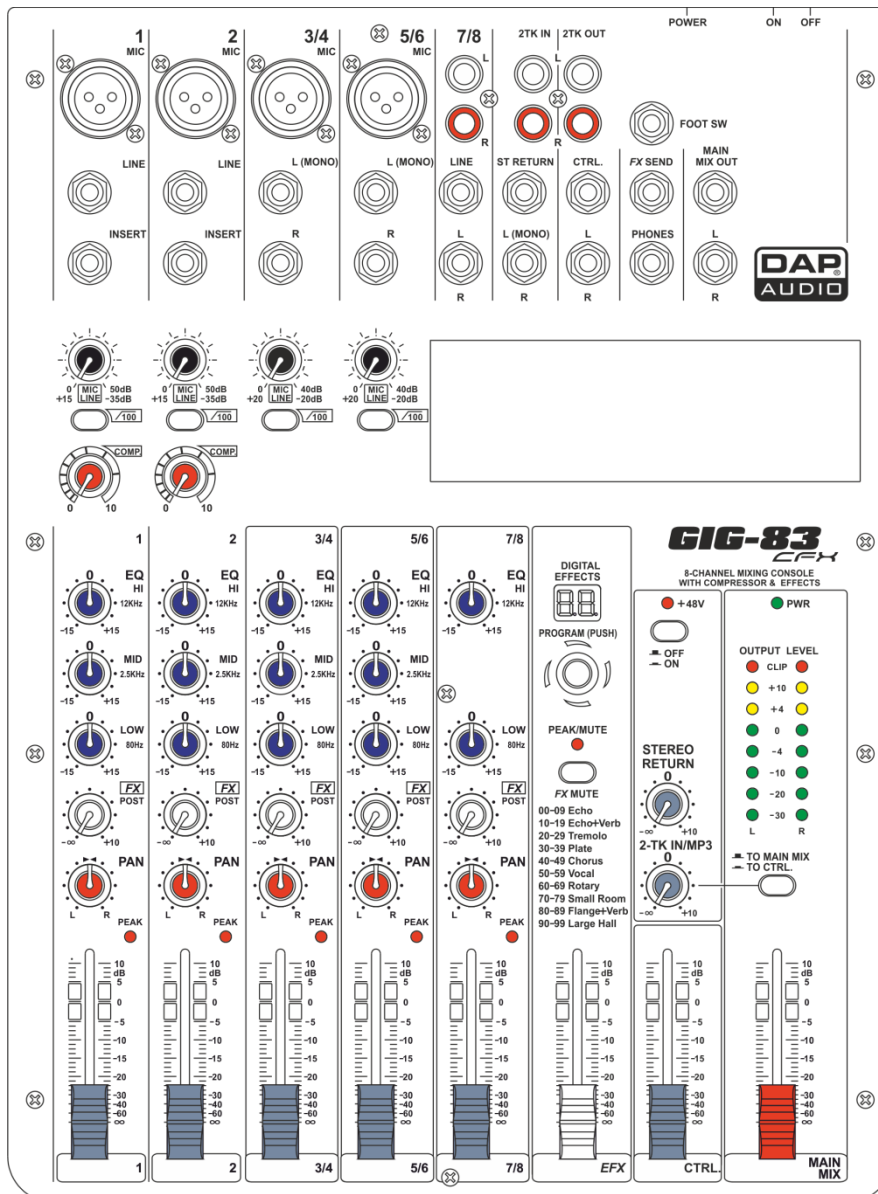

Installation

Introduction

This is a professional compact mixer that gives you great quality and better reliability than ever before. You will get the smooth, accurate more natural and open sound from this apparatus. It is really ideal for gigs, recording and fixed PA installations.

The GIG-83CFX Mixing Console is packed with features that cannot be found in other consoles of its size: 2 mono (provided with ultra-low noise microphone pre-amplifiers and Phantom Power at +48 Volt) and 3 stereo input channels, each of them provided with a 3-band equalizer for HI, MID and LOW controls, as well as 1 auxiliary control, highly accurate 8-segment bar graph meter and 2-track inputs assignable to main mix, control room/phones Outputs etc.

This unit is very easy to operate, but we advise you to go through each section of this manual carefully.

Ready to start

- 1) Please check the AC voltage available in your country before connecting your mixer to the AC socket.
- 2) Be sure that the main power switch is turned off before connecting the mixer to the AC socket. You should also make sure that all input and output controls are turned down. This will avoid damage to your speakers and avoid excessive noise.
- 3) Always turn on the mixer before you turn on the power amplifier; turn off the mixer after the power amplifier is turned off.
- 4) Before connecting and disconnecting the unit from the power source, always turn off the unit.
- 5) Cleaning: Disconnect the mains power supply and then wipe the mixer with a damp cloth. Do not immerse in liquid. Do not use alcohol or solvents.

Control Elements

1. MIC INPUT JACKS (CHs 1 to 5/6)

The balanced XLR input connects to microphones, DI boxes and multicores.

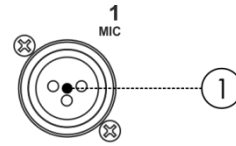

2. LINE INPUT JACKS (CHs 1,2)

This is a 1/4" jack connector which connects to line-level signal sources (for example, keyboards, CD players and wireless microphone receivers). The input is balanced (TRS connector) but can also be used with unbalanced connectors (TS connector).

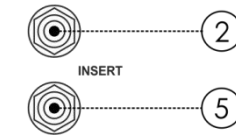

3. LINE INPUT JACKS (CHs 3/4 to 7/8)

The stereo channels consist of two line inputs (1/4" jacks), one for the left and one for the right channel. The inputs are unbalanced (TRS connectors). These channels can also be used as mono channels by connecting to the jack labeled "L" (left).

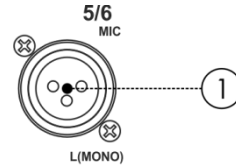

4. LINE INPUT JACKS (CH 7/8)

These are unbalanced stereo RCA pin jacks.

NOTE: Where an input channel provides both a MIC input jack and a LINE input jack or a LINE input jack and RCA pin jack, you can only use one pair of jacks at a time but not both pairs at the same time. Please connect to only one jack on each channel.

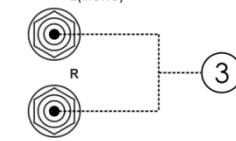

5. INSERT JACKS

The INS(ert) connector (1/4" stereo jack connector) is used to connect to external signal processors. Here you can hook up a compressor, noise gate or equalizer to process the signal of a single channel. The insert jack is placed before the fader, EQ and aux send. Please use an insert cable to connect to the insert point.



6. GAIN CONTROL

The GAIN CONTROL control adjusts the input gain.

Be sure to set this control fully counter-clockwise before you connect or disconnect a signal source to or from one of the inputs.

MONO: The first value range between 0 and +50 refers to the microphone input, indicating the degree of amplification applied to the input's signal. The second value range between +15 and -35 dB refers to the amplification of the line input.

STEREO: The first value range between 0 and +40 refers to the microphone input, indicating the degree of amplification applied to the input's signal. The second value range between +20 and -20 dB refers to the amplification of the line input.

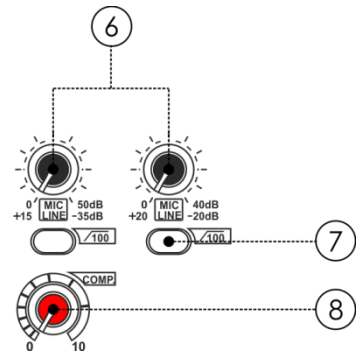
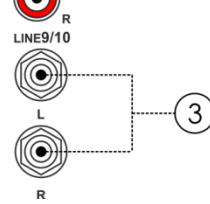

7. LOW CUT

Press the LOW CUT switch to activate the high-pass filter which blends out low-frequency noise (100 Hz, 18 dB/octave).

8. COMPRESSOR CONTROL

Adjust the amount of compression applied to the channel. Turn the control to the right to increase the compression ratio and the output gain will automatically be adjusted. The result is smoother, more even dynamics, because louder signals are attenuated when the overall level is boosted.

9. EQUALIZER

Hi

The high-frequency range is processed with a shelving filter above 12 kHz. You can boost or cut the bands up to 15 dB. When in center position (0 dB), the equalizer has a flat response.

MID

The HIGH MID control adjusts the mid frequency range. This is a peak filter which boosts and cuts the frequencies centered at 2,5 kHz. You can boost or cut the bands up to 15 dB. When in center position (0 dB), the equalizer has a flat response.

Low

The low-frequency range is processed with a shelving filter below 80 Hz. You can boost or cut the bands up to 15 dB. When in center position (0 dB), the equalizer has a flat response.

10. FX/POST

The FX bus is used as send path to the internal effect unit. The signal is tapped after the channel fader and therefore is affected by the position of the channel fader. The FX control adjusts the volume level of the channel signal to the effects unit.

11. PAN/BAL CONTROL

The PAN control determines the position of the channel signal in the stereo mix to which the channel signal is routed.

12. PEAK LED

The PEAK LED lights up as soon as the channel's level is too high. In this case, reduce the channel's input amplification with the GAIN control. The Peak LED lights at a level of 3 dB below clipping.

13. LEVEL

The channel fader adjusts the level of the channel signal as part of the main mix.

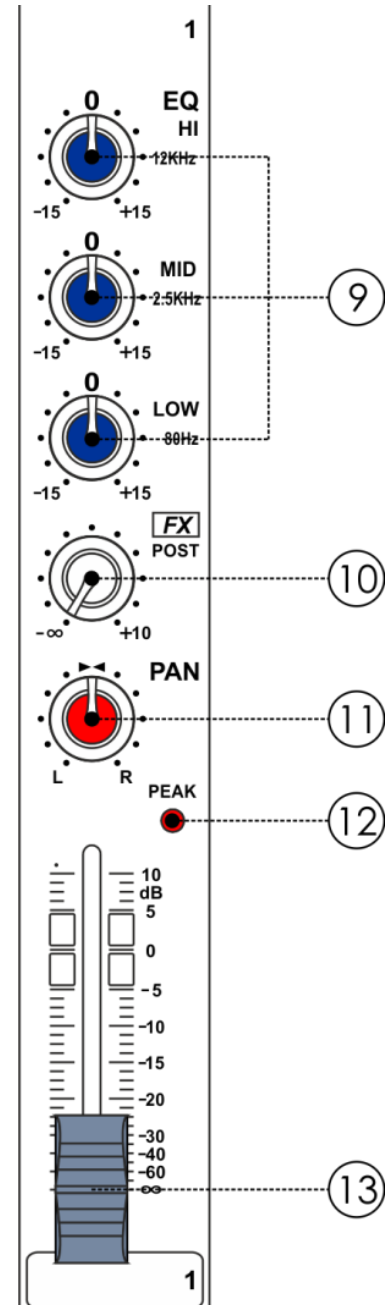

14. MAIN MIX LEVEL

Use this high-precision MAIN fader to control the output level of the main mix.

15. PHONES/CONTROL ROOM

The PHONES/CONTROL ROOM control adjusts the volume level of all solo signals routed to the headphone and the CONTROL ROOM outputs.

16. FX LEVEL

The FX LEVEL fader adjusts the volume level of the returned effect signal in the MAIN MIX.

17. 2-TRACK SIGNAL PATH

If you push down the 2 TRACK SIGNAL PATH switch, the 2 TRACK IN signal will be routed to the CONTROL ROOM output. Push the switch again, the 2TRACK IN signal will be routed into the MAIN MIX output.

18. 2-TK IN/MP3

This control allows you to adjust the level of the 2-tk in/mp3.

19. OUTPUT LEVEL

This stereo 8 segments LED meter will indicate the level of the overall output signal.

20. ST RETURN

This control assigns the ST RETURN signal to their respective MAIN MIX outputs.

21. FX MUTE CONTROL

This control is used to activate or deactivate the FX.

22. PEAK/MUTE LED

This LED lights up when the input signal is too strong. When the digital effect module is muted, this LED also lights up.

23. PROGRAM(PUSH)

Adjust this knob to select the desired effect. There are 100 options: Echo, Vocal, Plate and versatile two-effect combination.

24. DIGITAL EFFECTS

It displays the selected preset.

25. PHANTOM LED

This LED indicates when the phantom power is switched on for the microphone inputs.

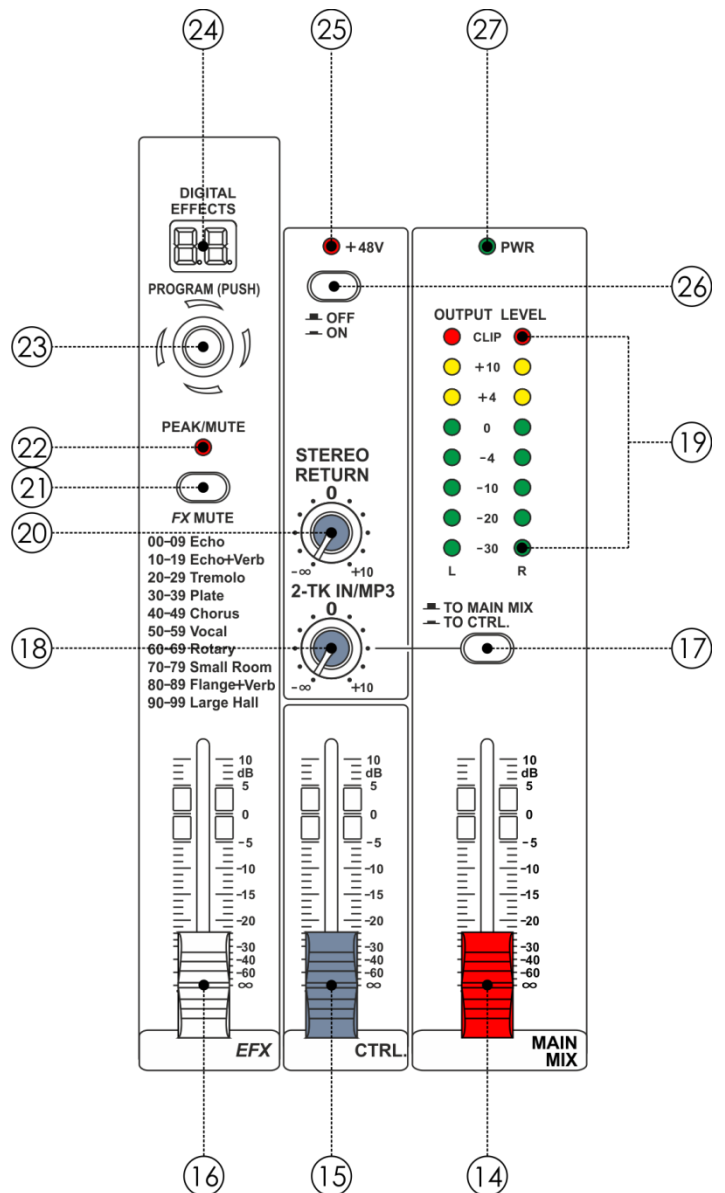

26. ON/OFF

Phantom power is used for operating a capacitor microphone. As a rule, dynamic microphones can still be used with phantom power, provided they are wired in a balanced configuration.

27. PWR LED

This LED indicates when the power is switched on.

28. 2TK IN/OUT

TAPE IN

The CD/TAPE input connectors are used to hook up CD players, tape decks or other line-level sources.

TAPE OUT

The CD/TAPE output connectors provide the stereo main mix signal to a tape deck or DAT recorder to record your mix.

29. FOOT SWITCH

This socket is used to connect an external foot switch for your convenient operation. It has the same function as the DFX MUTE switch.

30. ST RETURNS

The ST RETURNS inputs L and R let you connect the mixer to additional equipment (players, effects processors, submixers, etc.).

31. CTRL-ROOM OUTPUT

The CTRL-ROOM outputs will be used to send the signal to studio monitor speakers.

32. FX SEND

The FX SEND output provides the signal of the FX bus.

33. MAIN MIX OUTPUT

The MAIN MIX outputs are 1/4" TRS sockets and provide the main mix signal.

34. PHONES

The PHONES output lets you plug in your headphones.

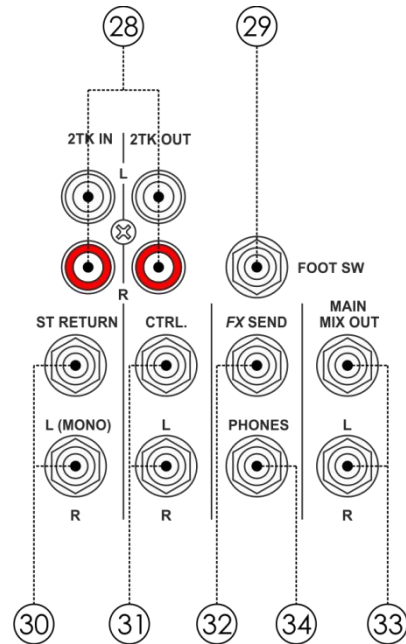

35. OPTIONAL MODULES SECTION



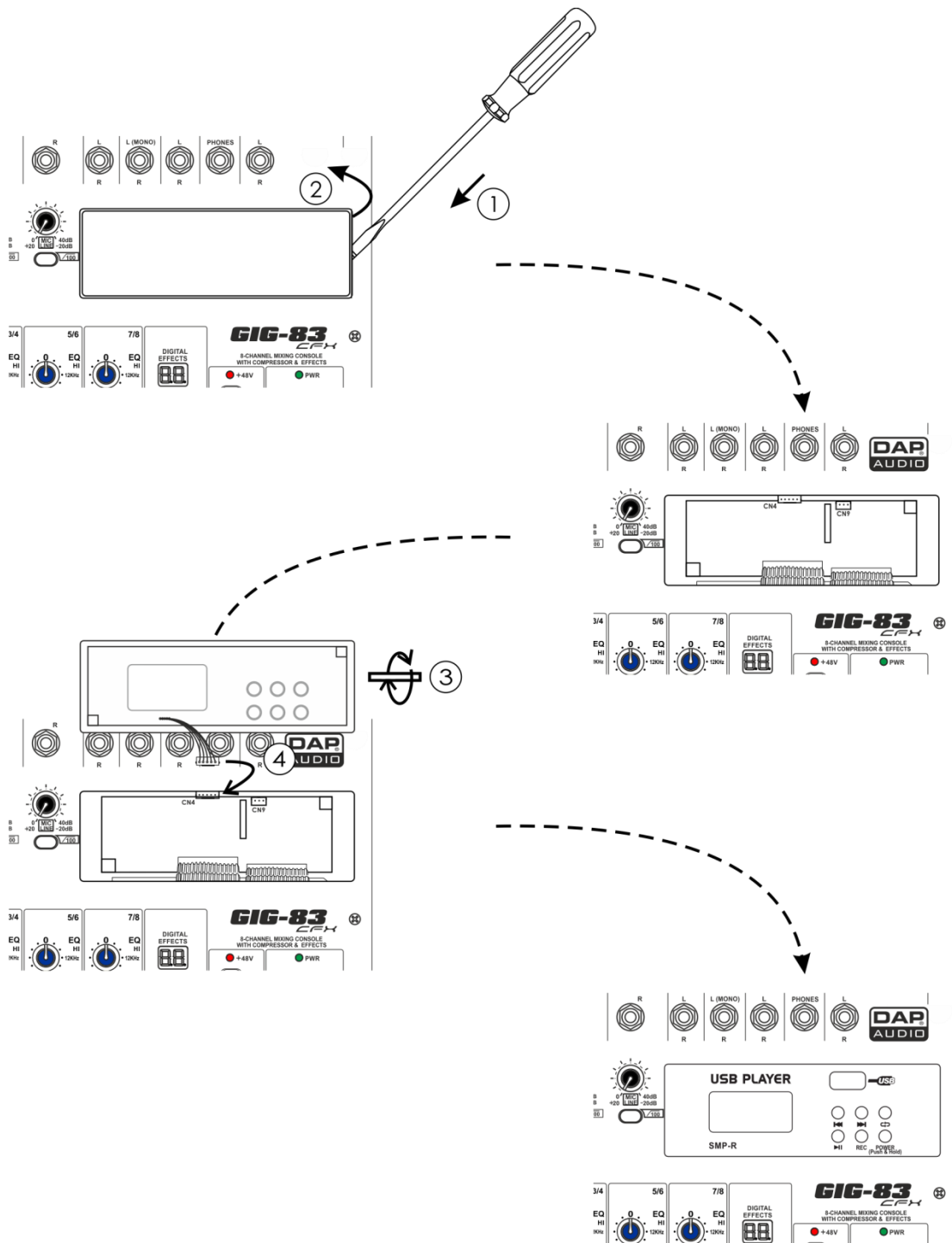
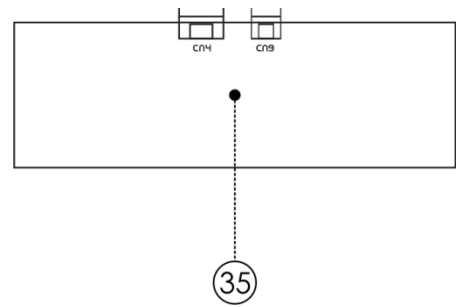

This section can be selected and installed according to the user's requirements. Open the cover and connect the module to connector CN4. The optional modules are: SMP-R, SMP-S, & Bluetooth-2.1. The signal for module playback can be assigned to Main Mix by 2TK routing. When using SMP-R recording function, the Cn9 needs to be connected. The signal comes from the Main Mix.



Modules







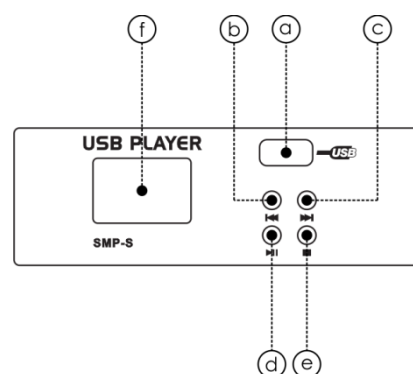





Option One - SMP-S (Order code: D2290)

The file system should be FAT16 or FAT32. This player can only decode MP3. It has 7 rank subordinate folders at most.

- A USB port: Allows the connection of any USB memory stick.
- B  PRE: Use this button to go back to the beginning of the current track or select a previous track for playing.
- C  NEXT: Use this button to skip to the next track.
- D  PLAY / PAUSE: Use this button to start playback. Press once to start playback, twice to set the pause mode and again to resume playback.
- E  STOP: Press this button to stop playback.
- F DISPLAY: All the USB player information is monitored through this display.



Operation Instruction for Song Module

- A When no USB memory stick is inserted, the display will show Fig. 01 (see next page)
- B Insert a USB memory stick, the USB player starts searching and the display shows "Searching". At the end of the search, the display will show the menu as shown in Fig. 02 (see next page). Using  PRE /  NEXT keys, you can select one of following three menu options ("Playing", "Program" and "Folder List"). Press Playing, the unit will enter into the corresponding operation mode.
- C "Playing" mode - single song play
 - 1). In Fig. 02 (see next page), select "Playing" mode. This display shows the names of all the folders containing MP3 files. Using the  PRE /  NEXT keys, you can scan the folders, then press  PLAY / PAUSE. It will open the corresponding folder. Press  STOP to return to Fig. 02 (see next page).
 - 2). After opening the folder, the display will show Fig. 03 (see next page). This display shows the MP3 file list. You can scroll the list using the keys  PRE /  NEXT. Choose the desired song. Press the  PLAY / PAUSE key, the selected song playback will start. In order to stop playback, you just need to press the  STOP key. Then, if you press the  PLAY / PAUSE key, the song playback will start from the pause point, if you press again the  STOP key, the system will return to Fig. 03 (see next page).

- D "Program" mode
- 1). In Fig. 02, select "Program" to enter into the following interface:
 "Play list Set ": Set the play list.
 "Playing List": Play list.
 Press ◀◀PRE/ ▶▶NEXT key to select, press ■ STOP key to return the Fig. 02.
 - 2). After entering into the "Play List Set", the display will show as Fig. 03. Selecting the desired folder, the display will show the following interface. The display will show all the MP3 files, the selected song will be inserted into the play list and a mark will appear. Press again and the song will be deleted from the play list and the mark will disappear. Press the ■ STOP key, you will return to Fig. 02. The play list can accept up to 20 songs and it will display the list according to song insert order.
 - 3). The display will show the following interface. Press the ◀◀ PRE / ▶▶ NEXT key, you can select the starting song, then press the ▶|| PLAY/PAUSE key, the selected song playback will start. Press ▶|| PLAY / PAUSE key again, or press ■ STOP key, the play back will stop. Press ▶|| PLAY / PAUSE key again, or press ■ STOP key, the playback will start again from the same point. Twice press ■ STOP, the USB player will return to Fig. 03.

E Folder List:
 Fig. 03 shows the MP3 file folder names. Use ◀◀ PRE/ ▶▶NEXT key to scan. Press the ▶|| PLAY / PAUSE button to enter the corresponding folder. In order to return to Fig. 05, you just need to press the ■ STOP button.

Fig. 01



Fig. 02



Fig. 03



Fig. 04

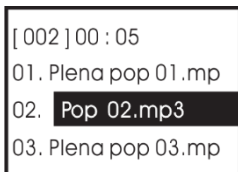

Fig. 05

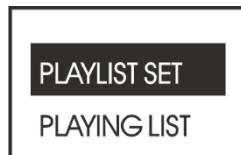

Fig. 06

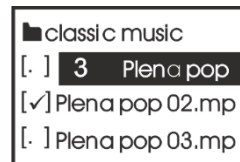
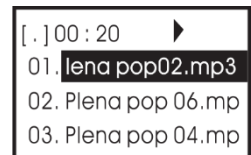







Fig. 07



Option Two - SMP-R (Order code: D2291)

The file system of USB memory for USB players is FAT16 and FAT32 and these players can only decode MP3. It has 7 rank subordinate folders at most.

- A USB port: Allows the connection of any USB memory stick.
- B  PRE: Use this button to go back to the beginning of the current track or select a previous track for playing.
- C  NEXT: Use this button to skip to the next track.
- D  RPT: Use this button to repeat one track, one folder or all tracks.
 Repeat All: Plays the complete medium several times, the symbol on the screen is 
 Repeat: Repeats a single track several times, the symbol on the screen is 
 Play in order: play all the tracks in order, the symbol on the screen is blank.
 Random play: All tracks will be played back in random order, the symbol on the screen is A.
- E  PLAY / PAUSE: Use this button to start playback. Press once to start playback, twice to set the pause mode and again to resume playback.
- F REC: Press this key to enable the recording preparation state. Press REC again to start recording. Any other operations are not available in the recording state until POWER is pressed to stop recording.
- G POWER(Push & Hold): When the power switch is pressed for 2-3 seconds, the device turns on.
- H DISPLAY: All MP3 player information is monitored via this display.

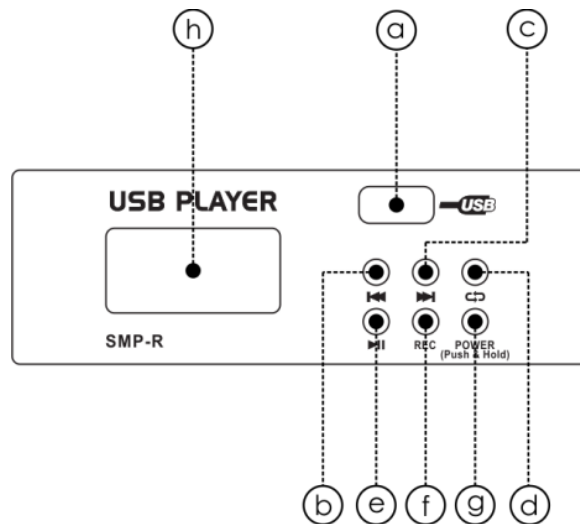

Option Three - Bluetooth Version 2.1 (Order code: D2292)

Can be paired with mobile phones, tablets or PC Bluetooth adapters to play stereo audio.

- A **DISPLAY**
These two LEDs are used to display different working states:
1) For the first time that the module is powered on, it is in stand-by state and the right LED flashes twice about 2 seconds.
2) Matching state, two LED's alternately flash quickly.
3) After connecting the device, the right LED is lighted constantly.
- B **⏮** **PRE:** Use this button to go back to the beginning of the current track or select a previous track for playing.
- C **⏭** **NEXT:** Use this button to skip to the next track.
- D **VOL-:** Press the VOL- button key to decrease the volume. The default factory setting is maximum.
- E **VOL+:** Press the VOL+ button to increase the volume.
- F **⏸** **PLAY/PAUSE:** Use this button to start playback. Press once to start playback, twice to set the pause mode and again to resume playback.
- G **PAIR:** Press this key and hold for 2-3 seconds, the player will change to matching state. In this state, the two LEDs alternately flash quickly and you can use your mobile phone, tablet or PC Bluetooth adapter to find devices, BT-2.1. If your device's Bluetooth version lower than 2.0, you should enter the password "0000". If your device's Bluetooth version higher than 2.0, you do not need to enter a password.

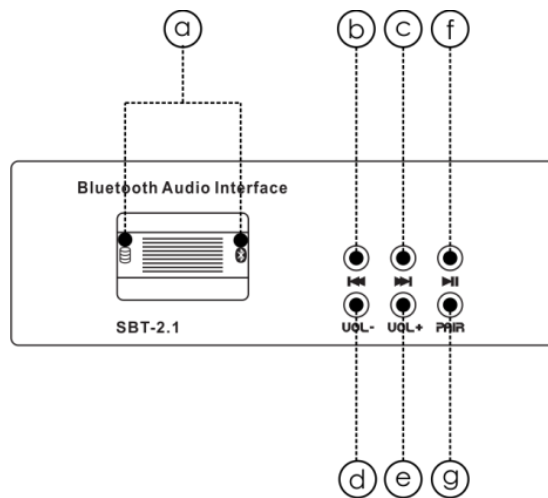

36. AC ADAPTER IN

This connector is used to connect the supplied AC adapter.

37. POWER ON / OFF

Use the POWER switch to turn on the mixing console. The POWER switch should always be in the "Off" position when you are about to connect your unit to the mains.

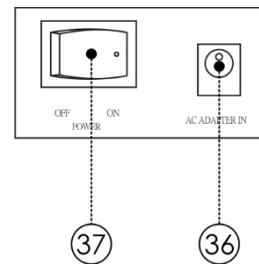

Installation and connection

At this point you are in a position to successfully operate your GIG-83CFX Mixing Console. However, we advise you to carefully read the following section to be a real master of your own mixer. Not paying enough attention to the input signal level, to the routing of the signal and the assignment of the signal will result in unwanted distortion, a corrupted signal or no sound at all. So you should follow these procedures for every single channel:

- Before connecting mics or instruments, make sure that the power of all your system components, including the mixer, are turned off. Also, make sure that all the input and output controls are turned down. This will avoid damage to your speakers and avoid excessive noise.
- Properly connect all external devices such as mics, power amplifiers, speakers, effect processor etc.
- Now, turn on the power of any peripheral devices, then power up the mixer.
- Set the output level of your mixer or the connected power amplifier at no more than 75%.
- Set the CONTROL ROOM/PHONE level at no more than 50%.
- Position HI, MID and LOW EQ controls on middle position.
- Position panoramic (PAN/BAL) control on center position.
- While speaking into the mic (or playing the instrument), adjust the channel Level control so that the PEAK LED will blink occasionally, in this way you will maintain good headroom and dynamic range.
- You can shape the tone of each channel by adjusting the equalizer controls as desired.
- Now repeat the same sequence for all the input channels. The main LEDs can move up into the red section, in this case you can adjust the overall output level through the MAIN MIX control.

Connection Cables

Take care of your cables, always holding them by the connectors and avoiding knots and twists when coiling them: This gives the advantage of increasing their life and reliability. Periodically check your cables. A great number of problems (faulty contacts, ground hum, discharges, etc.) are caused entirely by using unsuitable or faulty cables.

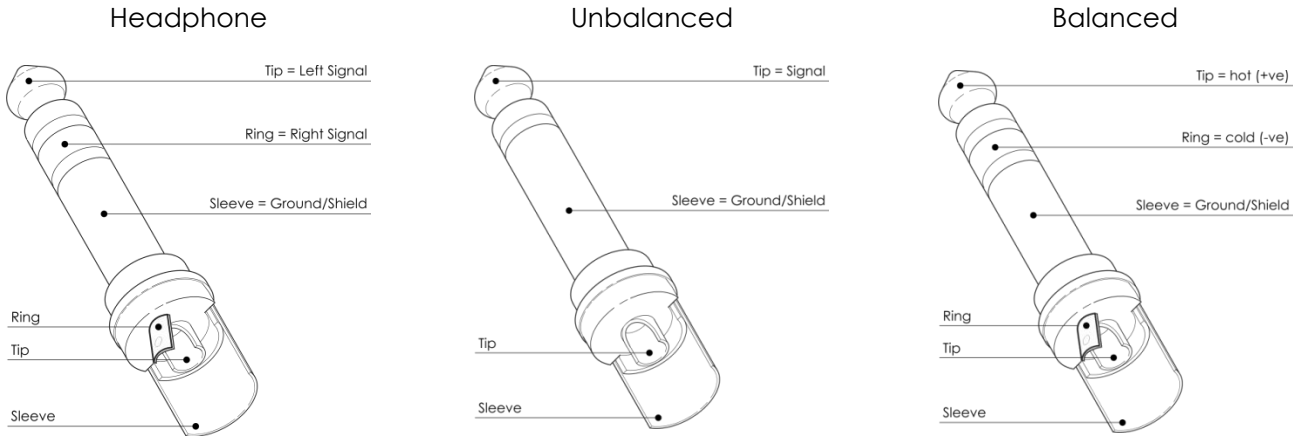

For these applications the unit provides 1/4" TRS and XLR connectors to easily interface with most professional audio devices. Follow the configuration examples below for your particular connection.

Unbalanced



Balanced

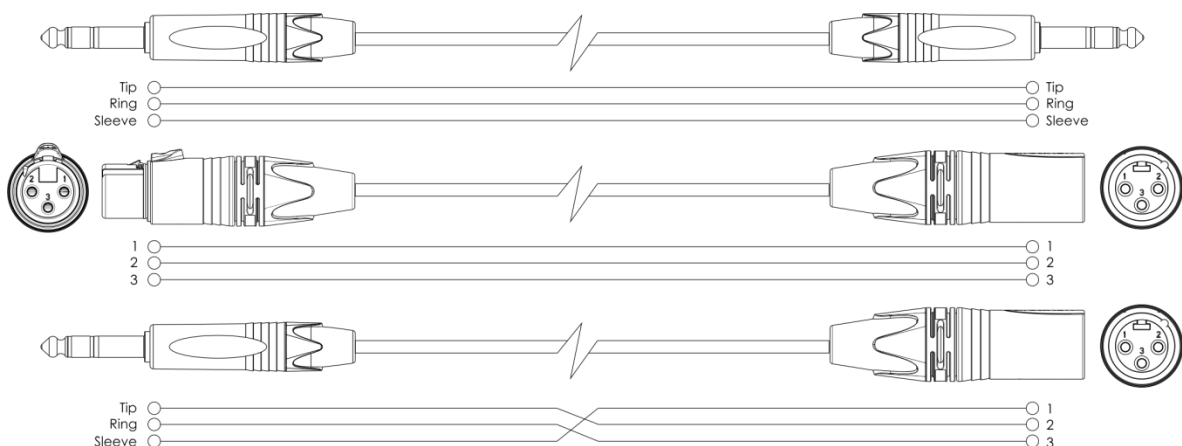

Block Diagram

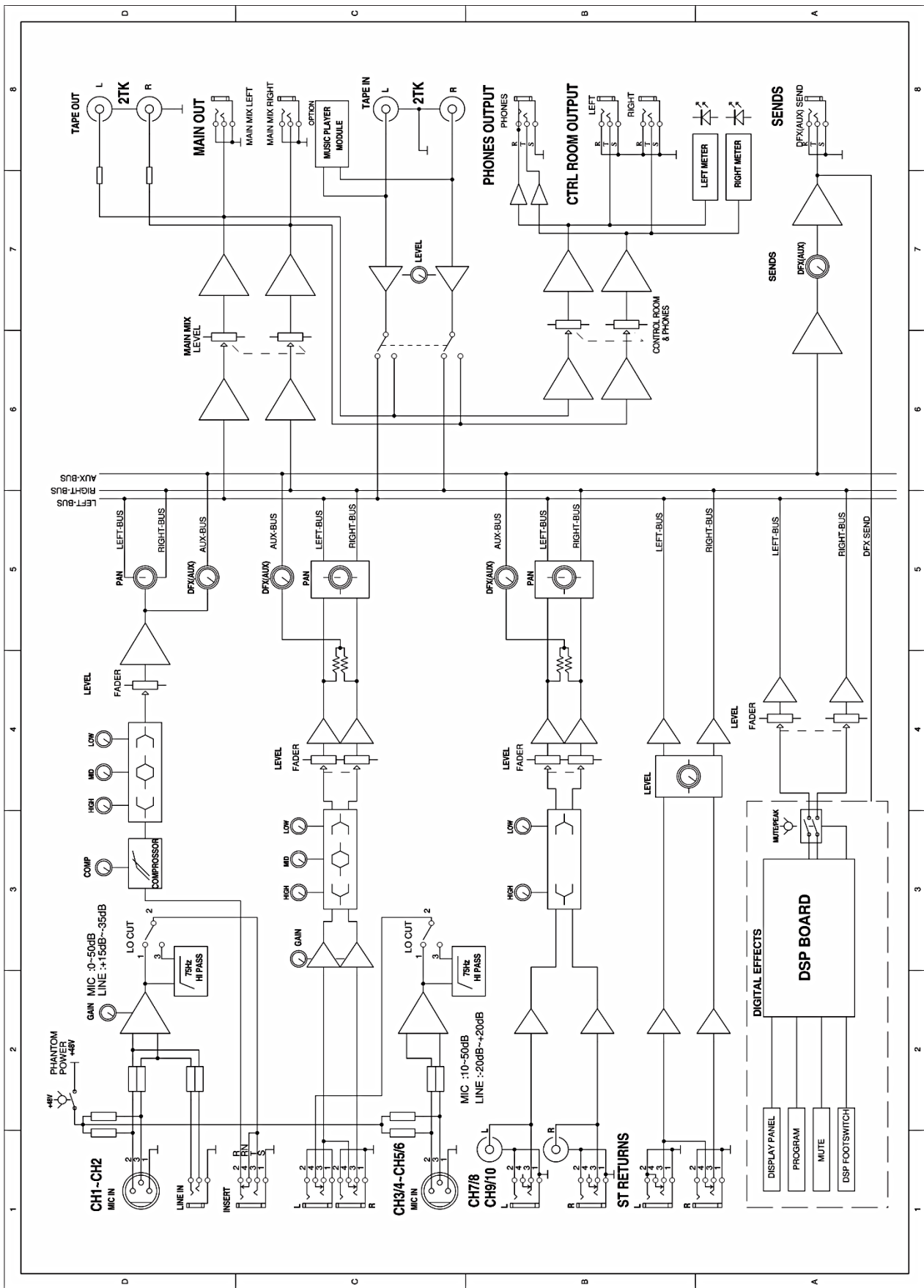

Presets List GIG-83CFX

No.	Preset	Description	Parameter
00~09	Echo	Reproduce the sound in input on the output after a lapse of time or delay.	Delay Time : 145~205ms
10~19	Echo + Verb	Echo with Room effect.	Delay Time : 208~650ms Decay time : 1.7~2.1s
20~29	Tremolo	Amplitude modulation of the signal.	Rate : 0.6 Hz~5 Hz
30~39	Plate	Simulate the transducers sound like classic bright vocal plate.	Decay time:0.9s~3.6s
40~49	Chorus	Recreate the illusion of more than one instrument from a single instrument sound.	Rate : 0.92Hz ~1.72Hz
50~59	Vocal	Simulate a small space with slight decay time.	Rev. decay time: 0.8~0.9s Pre-delay: 0~45ms
60~69	Rotary	Simulate the sound effect achieved by rotating horn speakers and a bass cylinder.	Modulation depth : 20%~80%
70~79	Small Room	Simulate a bright studio room.	Decay time : 0.7~2.1s Pre-delay : 20~45ms
80~89	Flanger + Verb	Simulate to play with another person carrying out same the notes on the same instrument and reverb.	Decay time : 1.5~2.9s Rate : 0.8Hz ~2.52Hz
90~99	Large Hall	Simulate a large acoustic space of the sound.	Decay time : 3.6~5.4s Pre-delay : 23~55ms

DIGITAL EFFECTS

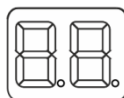

PROGRAM (PUSH)

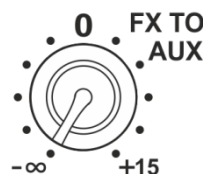

00-09 Echo
 10-19 Echo+Verb
 20-29 Tremolo
 30-39 Plate
 40-49 Chorus
 50-59 Vocal
 60-69 Rotary
 70-79 Small Room
 80-89 Flange+Verb
 90-99 Large Hall

Technical Specifications

MODEL:	GIG-83CFX mixing console	
Mono channels		
Microphone input	XLR balanced	
Frequency response	10Hz to 55KHz,+/-3dB	
Distortion(THD+N)	<0.03% at +0dB ,22Hz~22KHz A-weighted	
Gain range	0dB to 50dB	
Max. Input	+15 dB	
LOW CUT	100Hz	
SNR	<-100dBr A-weighted	
Phantom power	+48V with switch control	
Line input	1/4' TRS balanced	
Frequency response	10Hz to 55KHz,+/-3dB	
Distortion(THD+N)	<0.03% at +0dB ,22Hz~22KHz A-weighted	
Sensitivity range	+15dB~ -35dB	
COMPRESSOR	GAIN:0~9dB THRESHOLD:20dB---> ↓5dB	
Stereo input channels		
Mic input	XLR balanced	
LOW CUT	100Hz	
Line input	1/4' TRS or TRS/RCA un-balanced	
Frequency response	10Hz to 55KHz,+/-3dB	
Distortion(THD+N)	<0.03% at +0dB ,22Hz~22KHz A-weighted	
Sensitivity range	-20dBu~ +20dBu	
SNR	<-100dBr A-weighted	
Channels EQ		
	mono channel	stereo channel
High	+/-15dB@12KHz	+/-15dB@12KHz
Mid	+/-15dB@2.5KHz	+/-15dB@2.5KHz
Low	+/-15dB@80Hz	+/-15dB@80Hz
2-TACK IN		
TAPE IN	RCA jack	
Frequency response	10Hz to 55KHz,+/-3dB	
Distortion(THD+N)	<0.03% at +0dB ,22Hz~22KHz A-weighted	
Gain range	OFF to 15dB	
AUX RETURNS		
Input	1/4' TRS un-balanced	
Frequency response	10Hz to 55KHz,+/-3dB	
Distortion(THD+N)	<0.03% at +0dB ,22Hz~22KHz A-weighted	
GAIN range	OFF TO +15dB	
SNR	<-100dBr A-weighted	
Impedances		
Microphone input	1.8KΩ	
All other input	10KΩ or greater	
Tape out	1K	
All other out	120Ω	
DSP section (options)		
A/D and D/A converters	24bit	
Type of effects	Echo ,Echo+Verb , Tremolo , Plate , Chorus ,Vocal Rotary , Small Room , Flange + Verb , Large Hall	
Controls	Mute switch & Foot-switching with LED indicator 100 position preset selector(10 preseter * 10 variation)	
FOOT-SW	TIP:FX	SLEEVE:GND
Main mix section		
Max. MAIN MIX output	+22dBu XLR balanced (+16dBu un-balanced)	

Dimensions

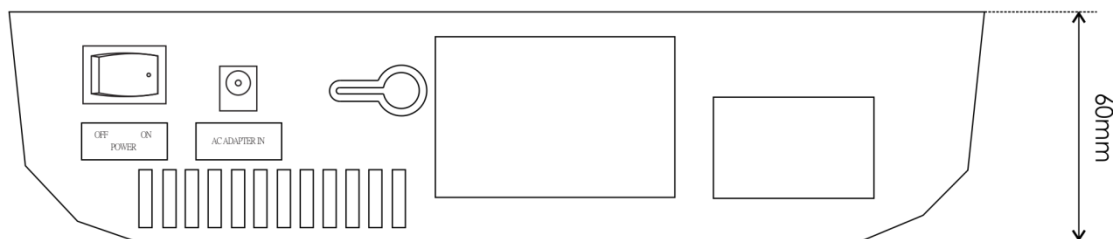
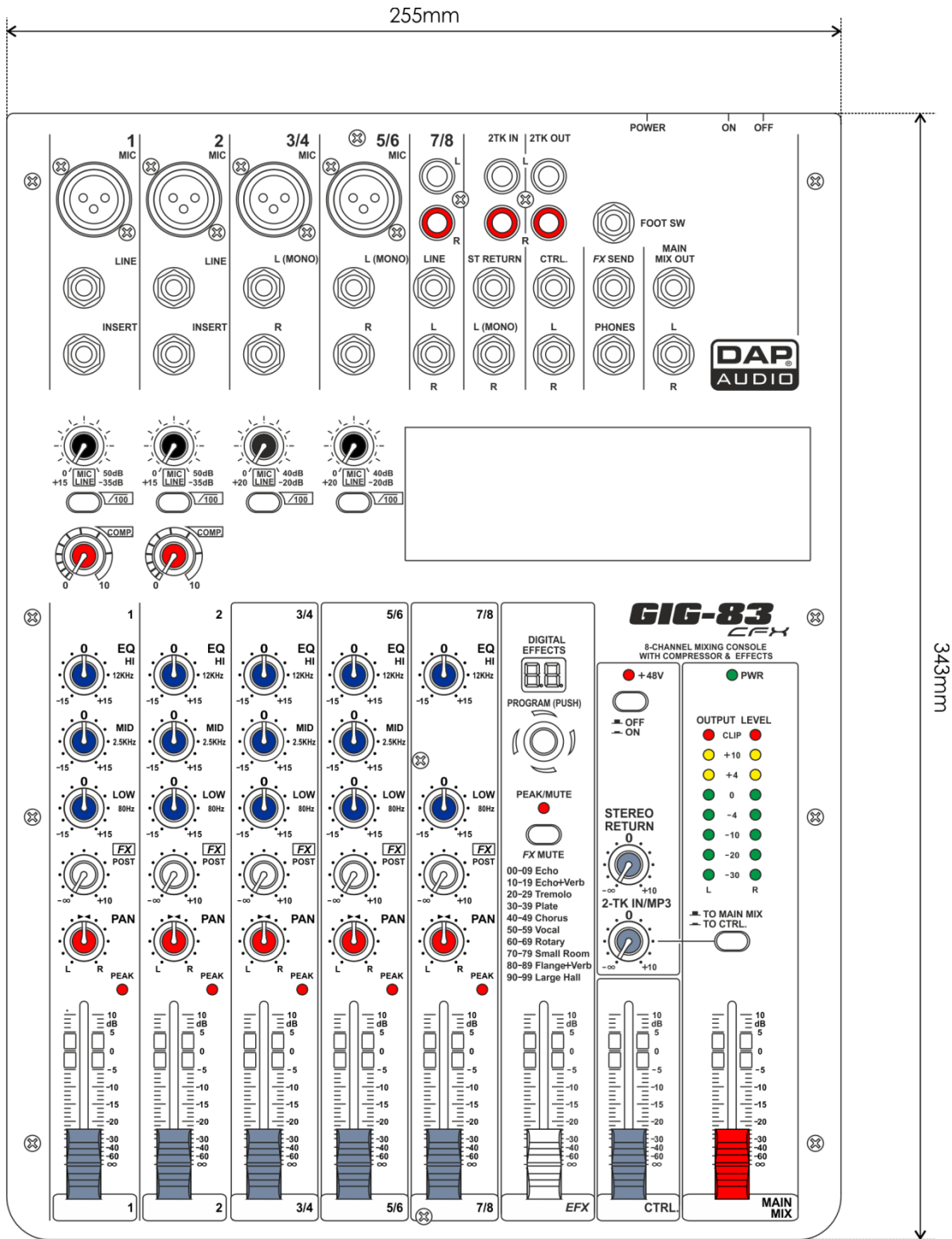



©2013 DAP Audio